

PERSONNEL

- Stephen Coonts** A former U.S. naval aviator, Stephen Coonts accumulated 1,600 hours in A-6 Intruders and made two combat cruises aboard the USS *Enterprise* during the Vietnam War. As well as providing the accurate technical detail in the bestseller *Right of the Intruder* (Simon and Schuster, 1986), Steve provided much more information in a very long transatlantic phone call. Steve also wrote *Final night* and *The Minotaur*.
- Pete Bonanni** Major, U.S. Air National Guard-F-4, F-16 and A-7 pilot who provided anecdotal information about the F-4.
- Norman Cosand** Ex-U.S. Air Force Captain-Flew Wild Weasel F-4 missions as a "Guy In Back" over North Vietnam. Provided useful information about F-4 missions and flight characteristics.
- Phil Handley** Colonel, U.S. Air Force (ret.)-Invaluable source of information about Phantom vs. MiG combat over Vietnam. Colonel Handley is credited with the only F-4 gun kill of a MiG-19 over North Vietnam.
- John McGinn** Lieutenant Commander, U.S. Navy Reserve-Veteran A-6 pilot who is still flying and provided invaluable checks on our A-6 accuracy and pictures.

If you have questions regarding the use of *Night of the Intruder*, or any of our other products, contact Spectrum **HoloByte** Customer Support at:



Spectrum HoloByte
2061 Challenger Drive
Alameda, CA 94501
Attn: Customer Support



(415) 522-1164
9:00 A.M. to 5:00 P.M. Pacific Time
Monday through Friday



America Online: SPHERE
CompuServe: 76004,2144
GEnie: HOLOBYTE
PC-Link: SPECTRUMH
Prodigy: TKNJ33A

Flight of the Intruder game and manual ©1990 Sphere, Inc. All rights reserved.
Flight of the Intruder and **Spectrum HoloByte** are trademarks of Sphere, Inc. All other trademarks are owned by their respective holders.

Come Fly With Me

by Stephen Coonts

A modern jet warplane is a strange, challenging machine; its cockpit is much different than the p/aces that most of us are familiar with. It's a flying Grand Prix racer, world-class superbike and a video game, all in one.



This magnificent machine slices through the atmosphere with a freedom that cannot be described, only experienced. A slave to your every whim, the aircraft responds to the slightest pressure on the controls, yet is ready to kill you the instant you make a false move. There is the darkness and the weather--nothing is as black as a night sky under a tropical overcast as you skim above the ground knowing the slightest caress from Mother Earth will be instantly, totally, fatal. There is the enemy-in combat they are doing their damndest to destroy your machine, and you with it. If you survive all that, then you may sample the piece de resistance, the night carrier landing, usually in foul weather, occasionally in a shot-up airplane. You come out of the goo and there is the deck, pitching gently with the meatball and the centerline lights and all you have to do is fly your airplane through the need/e's eye into an arresting gear wire.

So come on!

Come fly with me.

You awaken in the middle of the night, put on your stinky, green, one-piece flight suit and your steel-toed flying boots--you need the steel toes to keep your feet from being tom off by the instrument pane/ if you eject-and stumble through the passageways to the briefing room to learn your target and mission. You swig a cup of bitter coffee and don your flight gear in layers: G-suit, torso harness, survival vest, pistol, he/met, oxygen mask, gloves, flashlight, survival radios. You even wedge a candy bar and a plastic baby-bottle full of water into one of your G-suit pockets.

Out on the flight deck your aircraft is waiting. The night is hot and humid in the tropics--you quickly work up a sweat which soaks your underwear and flight suit and runs in salty rivulets into your eyes.

You examine the plane and its weapons with your flashlight. There are a lot of weapons on this A-6 tonight, ten 500-pound bombs, a dozen Rockeye anti-tank weapons at 500 pounds each, and a 2,000-pound belly tank on the center-line station, 16,000 pounds of internal fuel. The plane weighs 56,500 pounds for the catapult shot--over 28 tons. Over half that weight is fuel and ordnance.

CONTRIBUTORS

Concept and Design	Rod Hyde
Programming Team	Chris Orton, Colin Bell, James Taylor, Dave Whiteside, Steve Parys and Paul Dunscombe
Artwork and Animations	Mark Shaw, Jody Sather and Matt Carlstrom
Object Design and World Files	Paul Dunscombe, Stephen Tickle and Mark Shaw
Sounds	Colin Bell
AdLib and Digitized Sound	Lars Norpchen
Flight Models	Vera Piqueur, Colin Thorpe and Colin Bell
Manual	Steve Perrin, Rod Hyde, Marisa Ong, Nick Lavroff and Robert Giedt
Manual Artwork	Chuck Butler
Photo Reference	Stephen Coonts, Norman Cosand, Gilman Louie, Jack McGinn and Phil Handley
Programming Team Manager	Chris Orton
Product Manager	Rod Hyde
Testing	Tom "Kansas City" Basham, Kurt "Goat Killer" Boutin, Kasey "Lone Wolf" Chang, Anthony "Eraserhead" Chiang, Steve "Auger" Edwards, Mark "Endo" Estepha- nian, Bob "Extractor" Gong-Guy, Eric "Hairball" Grotke, Bradd "Bluto" Huddle, Paul "Eagle-Eye" Jepson, Peter "Death- wish" Koning, Cheryl "Dr. Mabuse" Mathison, Karl "Crooked Cat" Maurer, Mike "Mad Mongoose" Nebeker, Marisa "No. 19" Ong, Steve "White Knight" Perrin, Steve "Kingfish" Shirvanian, Peter "Bandit" Ward, Mike "Moondawg" Weksler and Bob "Phoenix" Wentzel
Special Thanks to	Phil Adam, Andy "Fretless" Edlen, Gilman Louie, Guymond Louie, Karen Sherman, Jim "RAM DOS" Sullivan and Jim Mackonochie

When you are satisfied that all is as it should be, or when you can put it off no longer, you climb the ladder into the cockpit, for this plane is big, with the cockpit rail nine feet above the deck. The plane captain helps you strap yourself to the ejection seat. Perhaps he says something he thinks is funny because you look like you need it.

On signal you bring the machine to life, start the engines, turn on the inertial navigation system, computer, radios, radar, the electronic countermeasures, and check the health of every system. A// go.

You sit staring across the deck at the inky blackness, at the other aircraft with other men like you, equally competent, equally scared, waiting.

Then the yellow-shirt taxi director gives the signal. You use throttle and brakes carefully, attentive to every twitch of his hand and nod of his head. There is little room on the aircraft carrier flight deck and most of it is taken. You get what is left over. You taxi slowly, obediently, alert for the exhausts of other aircraft or grease that will break your tires' adhesion to the anti-skid surface. The sea is out there in that blackness, waiting. As you taxi, you lower and lock the wings and drop the flaps and slats to takeoff position.

Onto the catapult. You feel the clunk as the shuttle captures the nose-tow link; you see the cat officer's signal to advance the throttles to full power. You shove the levers forward to the stops and take your feet off the brakes. The engines wind up with a howl audible even through the padding of your helmet.

Your breathing is rapid, the salt of your sweat stings your eyes as you waggle the controls and check the engine instruments. The machine trembles from the fury of the roiling air being sucked into the intakes and blown furiously out the exhausts.

You flip on the plane's exterior lights, you signal to the catapult officer that you are ready to fly, then put your head back into the headrest and wait for the shot.

Ahead of you is a hundred yards of dimly-lit deck, then nothing! The night is waiting to swallow you. Inside this machine full of fuel and laden with weapons, you will soon be thrown from this deck into that hot, humid, black air, 60 feet above the night sea, 15 knots above a stall. The enemy is also waiting, also ready-even now they are loading belts of ammo into the anti-aircraft guns and testing their missiles.

Your life will depend on your skill, your know/edge, your courage, your determination.

You blink the sweat from your eyes and take one more ragged breath.

The catapult fires and the G slams you back into your seat as the blackness hurls toward you.

Table of Contents

PERSONNEL	2
CONTRIBUTORS	3
Come Fly With Me	4
TABLE OF CONTENTS	6
PART I: INTRODUCTION	12
BACKGROUND	13
ABOUT THIS MANUAL	14
MINIMUM SYSTEM REQUIREMENTS	14
THE DISKS PROVIDED	15
INSTALLATION TO HARD DRIVE.....	15
PLAYING FROM THE FLOPPIES.....	15
PROBLEMS WITH INSTALLATIONS.....	16
SOUND SELECTION.....	17
CONVENTIONS USED IN THIS MANUAL.....	17
PART II: MENUS AND CONTROLS.....	18
THE PULL-DOWN MENU BAR	19
ABOUT Menu	19
FILE Menu	20
LEVEL Menu	21
CONTROL Menu	21
Input Device	21
Sound Options	22
Scale Control	22
Detail of Simulation Visuals	22
Other Factors	22
OPTIONS Menu	23
Engines	23
Armaments	23
Flight Model	23
Oppositidn Factors	24
Fuel	25
Indexing Preferences to Rank.....	25

COMMS Menu	26
The Comms Connection Details Screen	27
CONTROLLING YOUR AIRCRAFT	28
"FLYING WITH THE STICK"	28
Turns	28
Using the Mouse	29
The Rudder Turn	29
PAUSE	29
PART III: FIRST FLIGHT IN THE A-6 INTRUDER.....	30
THE DUTY ROSTER	31
Cockpit Orientation	33
What You Need to Know for Your First Flight.....	33
Other Views From Your Cockpit	34
First Strike Mission	36
Note for Users of the Tandy 1000	36
Landing	38
<i>A Typical Intruder Mission</i>	39
Finishing the Mission	42
PART IV: FIRST FLIGHT IN THE F-4 PHANTOM	43
SELECTING A PHANTOM MISSION	44
Cockpit Orientation	44
TAKEOFF PROCEDURES AND FIRST FLIGHT.....	45
Controlling Your Aircraft	45
About the BarCAP Mission	45
Going Into Combat	46
Using the Sparrow	47
Using the Sidewinder.. ..	48
Using the Vulcan M61A1 20mm Cannon	49
After the Battle	49
LANDING	50
<i>Flying The F-4</i>	51
Moving On.. ..	54
PART V: YOU AS CAG	55
PLANNING A MISSION	56
Summary of the Mission Planning Process	56

A MISSION OF YOUR OWN	57
Saving the Planned Mission	57
TARGET INTELLIGENCE	58
GENERAL INTELLIGENCE	59
POINTS OF INTEREST	60
WAYPOINTS	61
Moving the Position of the Current Waypoint	62
Editing Waypoint Dialog	62
USING THE ENCLOSED MAP	64
STORES	65
Optional External Fuel Tanks	66
Weapon Station Capacity	66
AIRCRAFT INFORMATION	68
Aircrew Personnel	70
Assigning Plane Crews	70
Replacing Pilot Teams	70
Personnel Descriptions	70
Meanings of Ratings Categories	71
A-6 Pilot Personalities	71
F-4 Pilot Personalities	73
Enemy Encounters	75
Air Encounters	75
Ground Encounters	75
SAMs	75
AAA	75
Rifles	75
Friendly fire	75
PART VI: OPERATIONS AND MISSIONS	76
SELECTING AN OPERATION	77
RULES OF ENGAGEMENT	77
COURT-MARTIAL	78
Operation BARCAP	79
Operation DECK ALERT	79
Operation TALLY HO YO	80
Operation BACK BREAKER	81
Operation MORNING SONG	82

Operation JULY 4th EVE	83
Operation JULY 4TH DAY	84
Operation JULY 4TH REFRAG	85
Operation LIGHTS OUT	86
Operation IRON RAIN I	87
Operation IRON RAIN II	88
Operation ALPHA STRIKE	89
Operation HUNTER KILLER	90
<i>The Most Dangerous Game</i>	91
PART VII: DEBRIEFING	94
OPERATION STATISTICS	95
SUCCESS RATING TABLE	96
Saving to Disk	97
BADGES	98
SIERRA HOTEL	98
MEDALS	99
PART VIII: FLYING AND FIGHTING	100
IN THE COCKPIT	101
The HUD Dot	102
Instruments In Common	103
Threat Indicator and Panel	104
Reading the COMED	105
Phantom System Lights	105
Intruder Warning Lights	106
Intruder Multiple Weapon Selection Panel	107
Phantom Warning Light Panel	107
Displays Unique to the Phantom	108
The Phantom Radar Screen	108
Reading the Radar Screen	109
Phantom G-Force Gauge	110
OFFICER TRAINING	111
THE NATURE OF G FORCES	111
AIR COMBAT MANEUVERS	114
FUEL MANAGEMENT	120

Fuel Limits	120
USING THE RADIO	121
PHANTOM MULTIPLE WEAPON SELECTION PANEL.....	122
AIR-TO-AIR WEAPONS	122
AIM-7 Sparrow.....	123
AIM-9 Sidewinder.....	124
Gun and Rockets	125
BOMBING MISSIONS	126
intruder Missions	126
Normal Strike Missions	126
Alpha Strike	126
Dive Bombing..	126
Stephen Coonts' Technique	126
BOMBING TECHNIQUES	127
Using DIANE	127
Using Direct	128
Using Dive Toss	129
MIL DETERMINATION TABLES	130
AIR-TO-GROUND WEAPONS	132
AGM-45A Shrike	132
AGM-78 Standard	132
AGM-62 Walleye	133
LGB Paveway	134
LAU-3A ZUNI Rockets..	135
iron Bombs	135
PART IX: CARRIER LANDINGS	137
INSTRUMENTATION TO HELP WITH LANDING	138
The Meatball	138
AOA Indexer	139
GETTING HOME	139
Manually	139
By Autopilot.....	139
Indexing ADA to Pitch	139
Automatic Carrier Landng System (ACLS) Indicator	140
PRACTICE LANDINGS	140

PART X: AIRCRAFT SPECIFICATIONS	142
A-6 INTRUDER	143
F-4 PHANTOM ii	144
MIG-21	145
MIG-19	146
MIG-17	147
SUMMARY COMPARISONS	147
PART XI: THE NAVAL AIR WAR IN VIETNAM	148
PART XII: GLOSSARY AND ABBREVIATIONS	157
KEYBOARD LAYOUT	168
PART XIII: THE KEYBOARD	170
KEY COMMAND DESCRIPTIONS	172
PART XIV: EXAMPLE OF PLAY	179
FURTHER READING	184
PART XV: INDEX	185
A FINAL WORD	192

PART I: INTRODUCTION

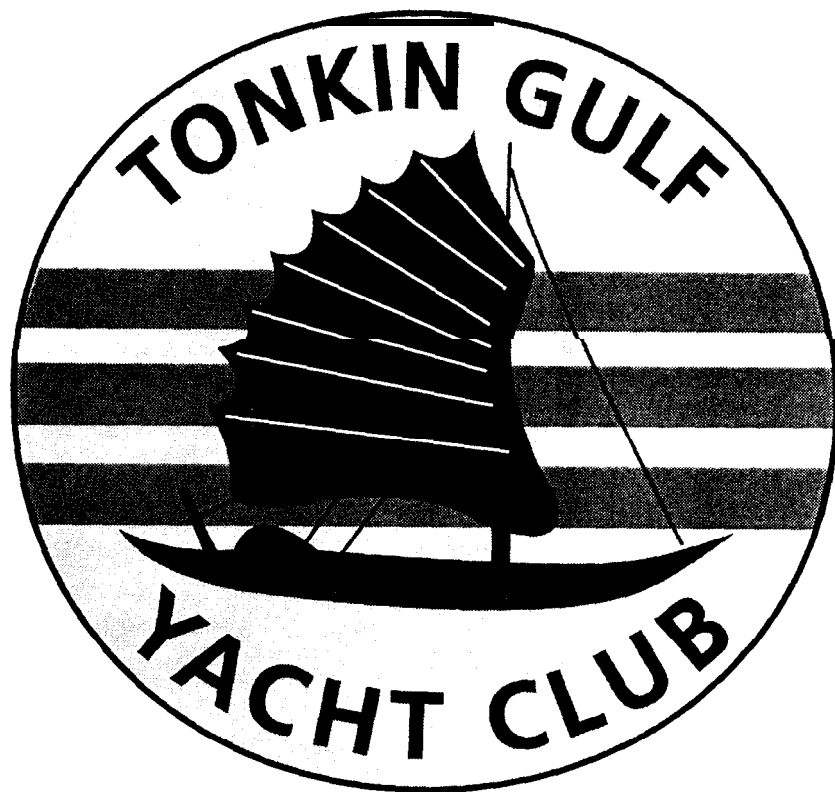

BACKGROUND

This simulation takes place just prior to and during the Linebacker campaign in 1972 over North Vietnam. The object of the game is to complete assigned missions and do it with minimum losses of equipment and personnel. Usually, but not always, a mission is part of a larger operation and is undertaken by one of several sections of aircraft. For example, a section of F-4 Phantoms could be given a MIGCAP mission and a section of A-6 Intruders could be assigned the bombing mission as part of an overall operation to destroy a bridge. In some cases, such as the "Morning Song" operation, only one section of Intruders is used so that the mission is effectively the same as the operation.

You can take the role of a Phantom pilot, an Intruder pilot or the Commander Air Group (CAG) based on a carrier at Yankee Station. The CAG is primarily responsible for planning missions, but he can fly any aircraft in the mission if he chooses to do so. Using this game, you can plan your own missions against famous targets in Vietnam such as the Yen Bai Railroad Bridge or the thermal power plant at Hanoi.

Success is measured by operation completion and safe return of all aircraft. Individual survival, while important, is not the sole measure of success. More over, it can be just as important how you win as if you win. If the Rules of Engagement are in force and you violate them, it will not matter how vital the target you hit-you're headed for a court-martial.

A key feature of this simulation is that there can be many friendlies (up to eight, arranged in four flights of Intruders or Phantoms) as well as many bogeys. Friendlies can have different missions in the same operation. You may be on a bombing run and see either a friendly Phantom protecting you from MiGs or an A-6 attacking SAM sites to protect you. Alternatively, you can do the protecting as an A-6 friendly goes on the bomb run. Moreover, you can take the role of any friendly at any time.

No matter what role you take, you can switch aircraft in mid-mission and always be where the action is. If you are flying an A-6 in to bomb a bridge, you can switch to the covering F-4s to dogfight the MiGs coming up to stop you, switch back to the A-6s to make the actual bombing run, and then switch back to the Phantoms to cover the retreat.

In short, with this game you can participate in every facet of the deadly air war over North Vietnam, 1972.

ABOUT THIS MANUAL

You don't have to read every word in this manual in order to see action over southeast Asia. If you prefer to learn by trial and error, go to page 30. This puts you in the cockpit of an A-6 Intruder and shows you how to select a mission and fly it. In the process you get a command summary and an overview of the game, giving you enough information to fly the A-6 and use the Walleye missile. From there you can turn to page 43 and learn the basics of the F-4 Phantom, or perhaps use the rest of the manual for in-depth information on any of the game components.

On the other hand, if you are fairly new to this kind of game, we recommend you take a little time to read the introductory material in the manual and undertake the first missions described. Flying a Phantom or an Intruder is a challenging task and involves skills that are best learned through step-by-step instructions. Once you feel proficient flying either aircraft, then you can undertake some of the more advanced missions. Missions are described in detail in Part VI.

The next pages show you how to install the software for the first time and introduce you to some of the conventions used in this manual. It's important that you read that section; otherwise, later sections of the manual may not make much sense. The next section, Part II: Menus, tells you how to use the pull-down menus to customize the game to your liking and how to use the keyboard, joystick or mouse to control your aircraft.

Part III is the aforementioned first flight in the Intruder; Part IV is the first flight in the Phantom. Part V introduces you to the duties and responsibilities of being the CAG (Commander Air Group) and allows you to create your own operations. Part VI describes the preset missions waiting for you; Part VII takes you through the debriefing and tells you what the rewards of the game are.

Part VIII gets into how to fly the aircraft and understanding the cockpit. It provides a brief tutorial on how to dogfight and bomb. Part IX is a special section devoted to that most impossible of all flying feats, the carrier landing, and gives you some insight on how naval aviators perform this miracle every day.

Part X of the manual provides information about the aircraft (both friendly and bandit), Part XI is a history of the naval air war over Vietnam, Part XII is a glossary of the terms used in this book and by aviators in general, and Part XIII describes every key used in this game and provides a keyboard layout (which is repeated in a separate enclosure for easy reference). Part XIV is a description of a mission run by one of our playtesters who tried to duplicate Jake Grafton's feat in the original book. Finally, Part XV is the index to the manual.

MINIMUM SYSTEM REQUIREMENTS

To play this game, you must have an IBM PC or compatible. Your machine must have at least Turbo XT speed (7MHz 8088) and 640K RAM. At least 527K RAM (540,000 bytes) must be accessible to the program (see page 16).

THE DISKS PROVIDED

This package includes either 1) disks for 5 1/4" drives consisting of two 360K disks for CGA and one 360K disk and one 1.2MB disk for EGA/VGA, or 2) disks for 3 1/2" drives consisting of one CGA 720K disk and two EGA/VGA 720K disks. If you need a format other than those provided, please see the enclosed coupon.

- Before doing anything further, make backup copies of the disks provided, using whatever copy utility you prefer. Put the original disks in a safe place and either play or install the game with the copies.

INSTALLATION TO HARD DRIVE

To install the CGA/Hercules version to a hard drive:

- Copy all the files from either the two 360K disks for CGA or the 720K Disk for CGA to a subdirectory.

To install the EGA or VGA version of this game to your hard drive:

- Insert the 1.2MB disk or 720K Disk 1 for EGA/VGA into the floppy drive.
- Change to the drive and directory where you want to install the game. Be sure to go to the exact directory where you want the game. For example, if you have a GAMES directory, then type `C :` and then `CD\GAMES`. Of course, you can just install it directly on drive C.
- Type `A:INSTALL` at the `>`.
- First pick the graphics mode appropriate to your system by choosing it with `+>` and `<+>` and selecting with `Enter`. Then select what kind of disks you are installing from and then the drive you are installing from. You are then shown the destination path. In the above example, it would read `C:\GAMES\INTRUDER` if that is what you want, press `Enter`. If it isn't what you want, you can edit the path by deleting letters with the `Backspace` and retyping, then pressing `Enter`. When finished, the installation will create a subdirectory called INTRUDER on the drive and directory you have indicated.

PLAYING FROM THE FLOPPIES

To play the CGA or Hercules version from floppies:

- Insert the 360K Disk 1 for CGA or the 720K Disk for CGA into a drive and type `INTRUDER` or `HINTRUDER` for Hercules. If you are playing from 360K disks, you need to swap disks or use two floppy drives.

To play the EGA version from the disks:

- Insert the 1.2MB Disk or the 720K Disk 1 for EGA/VGA into the appropriate drive.

Type `INTRUDER`. If you are playing from one 31/2" disk drive, you will be prompted to insert Disk 2 midway through loading. You can also play the game from two 3 1/2" disk drives.

You cannot play the VGA version from the disks provided. You must install it on your hard drive; see the previous page.

PROBLEMS WITH INSTALLATION?

If you are having problems running Flight of the Intruder, please try the following.

1. You'll need to run CHKDSK, a DOS utility, first to determine how much free RAM you have available. Type `CHKDSK` at the DOS prompt.
2. The bottom two lines on your screen will show the total memory in your computer and the amount of memory available to the game. The number on the last line needs to be at least 540,000 (the equivalent of 527K) in order for *Night of the Intruder* to run in EGA or VGA or 490,000 (477K) for CGA. Otherwise, when you type `INTRUDER`, the game will simply return to the DOS prompt.
3. Remember that RAM-resident programs, such as menu programs, DOS shells, print spoolers, buffers, mouse drivers, network drivers and other programs, can use up part of your total available RAM. If you do not have at least 540,000 bytes of free RAM, you need to do one of the following:
 - a. Create a bootable floppy disk by inserting a blank disk in drive A and typing `FORMAT A: /s`. (FORMAT is another DOS utility program.) This makes a clean system disk. If you want to use your mouse, you must install the mouse driver to this system disk. To use the new disk, turn your machine off and reboot with the new system disk in drive A. Then run *Flight of the Intruder* by changing to the drive where you have the game and typing `CD\INTRUDER` and then `INTRUDER`.

OR

- b. Rename your `AUTOEXEC.BAT` and `CONFIG.SYS` files to other names. For example, type `RENAME AUTOEXEC.BAT AUTOEXEC.BAK` and `RENAME CONFIG.SYS CONFIG.BAK`. Reboot your machine, and run CHKDSK again. If you have at least 540,000 free RAM, try running *Night of the Intruder* by typing `INTRUDER` at the appropriate directory. Remember to rename the `AUTOEXEC.BAT` and `CONFIG.SYS` files back to their original names when you are through playing and before rebooting your machine.

SOUND SELECTION

On the **FILE** menu (see page 20) you have the choice of three types of sound.

AdLib	Requires 12MHz	80286 minimum
Digitized	Requires 12MHz	80286 minimum
PC Tones	Requires 7MHz	8088 minimum

For the AdLib sound, use amplified speakers to hear the sound effects clearly. The CGA/Hercules version only supports PC Tones sound. If you want no sound at all, select the "All Sound Off" option from the **CONTROL** menu. Pressing `S` toggles through the **CONTROL** menu sound options at any time.

CONVENTIONS USED IN THIS MANUAL

Input Devices

You can use the keyboard or a mouse when you need to choose from a number of different options. To avoid multiple instructions, we will use the term select to describe this process, no matter which input device you use. If you are using a **joystick**, you must select options with the keyboard. Joysticks can only be used for combat maneuvering.



If you are using the **keyboard**, you can select the option directly by pressing the key shown at the lower right corner of the icon. For example, to select **OK** from the above selection screen, simply press `Enter`, the key shown at the lower right corner of the icon. Use the arrow keys to move up and down the pull-down menu.

Instead of pressing the particular key (such as `I` for information) you can use `Tab` to move the highlight left to right from one icon to the next. Then press `Spacebar` to select the icon you are highlighting.

If you are using a **mouse**, you can select the desired option just by pointing to it and clicking the left mouse button. You can also use the mouse to point to a menu item and select it. Using the right mouse button keeps the menu on screen if you need to make several selections at once (see Part II: Menus).

Step-By-Step Instructions

When you need to do something (such as press a key or select an option), we use the following format:

- Press `+` to increase thrust to the maximum value.

This way, you'll be able to distinguish between instructions and explanations with just a glance.

PART II: MENUS AND CONTROLS

THE PULL-DOWN MENU BAR

Press **[F10]** at any time to display the menu bar at the top of the screen. Once you display the menu bar, the game is stopped. It remains paused until you use the "Return" option from the **FILE** menu or press **[Enter]**. Menus can only be accessed with the keyboard or a mouse.

The game will save all choices you have made to go with your name and callsign and give you the same options again the next time you fly with that name and callsign. If you wish to fly with different options, you must either rechoose the options, or pick a different pilot name and callsign and set up different options for that name. This means that if you want to change the calibrations on the input device you are using or change the actual device from one joystick to another or one mouse to another, you must choose the name and callsign **before** calibrating the device or the saved calibration will override your new calibrations.

Each of the six menus in the menu bar contains a number of options. However, the **ABOUT**, **LEVEL**, **OPTIONS** and **COMMS** menus are only available **before** you get into the cockpit to fly a mission. The menus remain hidden until you access them using one of the following methods, depending on the input device you are using:

Keyboard

Press **[←]** or **[→]** to highlight the menu you wish to activate. Press **[↑]** and **[↓]** to highlight the option of your choice and then press **[Enter]**; the menu will then go away. If you want the menu to remain on the screen until you make several choices from the same menu (as you might wish to do from the **FILE**, **CONTROL** and **OPTIONS** menus), use the **[5]** on the number pad to make your choices.

Mouse

Move the pointer to the menu you wish to activate, and press the left mouse button. The menu options pop down, remaining displayed for as long as you hold the button down. To select a menu option, move the pointer down to highlight the option of your choice and release the button. If you wish to make several choices on one menu, use the **right** mouse button to pull down the menu and make the choices.

Joystick

You cannot use the joystick to select menu options.

The following is a description of the menu options within each of *Night of the Intruder's* six menus.

ABOUT Menu

This provides information about the game itself. Choosing this menu displays the credits, the version number and other information about the simulation.

PART II: MENUS AND CONTROLS

THE PULL-DOWN MENU BAR

Press **F10** at any time to display the menu bar at the top of the screen. Once you display the menu bar, the game is stopped. It remains paused until you use the "Return" option from the **FILE menu** or press **Enter**. Menu can only be accessed with the keyboard or a mouse.

The game will save all choices you have made to go with your name and callsign and give you the same options again the next time you fly with that name and callsign. If you wish to fly with different options, you must either rechoose the options, or pick a different pilot name and callsign and set up different options for that name. This means that if you want to change the calibrations on the input device you are using or change the actual device from one joystick to another or one mouse to another, you must choose the name and callsign **before** calibrating the device or the saved calibration will override your new calibrations.

Each of the six menus in the menu bar contains a number of options. However, the **ABOUT**, **LEVEL**, **OPTIONS** and **COMMS** menus are only available **before you** get into the cockpit to fly a mission. The menus remain hidden until you access them using one of the following methods; depending on the input device you are using:

Keyboard

Press **←** or **→** to highlight the menu you wish to activate. Press **↑** and **↓** to highlight the option of your choice and then press **Enter**; the menu will then go away. If you want the menu to remain on the screen until you make several choices from the same menu (as you might wish to do from the **FILE**, **CONTROL** and **OPTIONS** menus), use the **5** on the number pad to make your choices.

Mouse

Move the pointer to the menu you wish to activate, and press the left mouse button. The menu options pop down, remaining displayed for as long as you hold the button down. To select a menu option, move the pointer down to highlight the option of your choice and release the button. If you wish to make several choices on one menu, use the **right** mouse button to pull down the menu and make the choices.

Joystick

You cannot use the joystick to select menu options.

The following is a description of the menu options within each of Flight of the Intruder's six menus.

ABOUT Menu

This provides information about the game itself. Choosing this menu displays the credits, the version number and other information about the simulation.

FILE Menu

The **FILE menu** lets you manipulate the simulation (or "file") at hand. By selecting from the following options, you can abort, postpone or end an operation, as well as return to the operation from which you accessed the **FILE menu**. You can also end the game and return to DOS.

Abort Mission: Returns you to the Duty Roster. This is otherwise known as "giving up." Needless to say, you are awarded no points for an aborted mission.

End Mission: Takes you immediately to the end of the mission, whether or not you have attained the objective. Use it for eliminating the tedium of a return-to-carrier trip and the anxiety of a carrier landing. The mission is over; you go immediately to Debriefing and get your scores.

Return: Returns you to the operation without change.

Exit: Exits the game into DOS. No score is recorded.

Take Photo: Allows you to take a photograph of what is on the screen at the moment you choose the option. This comes in handy for later reference during Debriefing. While flying, you can use **[PrtSc]** for the same result.

Camera On: This turns on the "videotape camera" to record action sequences during a game. This can only be accessed while in flight. It can also be used by pressing **[V]**.

PC Tones: Gives you sounds directly from the PC's minimal speakers. While the sound is not very realistic, using this sound mode gives you an indication of actions taking place and speeds up the game compared to digitized or AdLib sound.

Digitized: Uses a digitizing routine to give a more realistic range of sounds for the game at the loss of some speed. We strongly recommend that you not use this setting unless your machine is at least a 12MHz 80286.

AdLib: Takes advantage of the AdLib sound card to provide excellent sounds for the game, again at the expense of some speed. We strongly recommend that you not use this setting unless your machine is at least a 12MHz 80286 and you have amplified speakers.

The following options can only be accessed during Mission Briefing or Debriefing. Pressing **[Esc]** takes you back where you came from.

Slide Show: This allows you to go to the Debriefing Photograph screen to look at any photographs you have taken and saved.

Video Replay: This allows you to replay any previously saved videos.

Sierra Hotel: This shows you the current top ten pilot list for the game.

Awards: This shows you what awards the pilot has already earned.

LEVEL Menu

Use the **LNEL menu** to choose the level of difficulty of the simulation, from "Lieutenant j.g." (the easiest) to "Captain" (the most difficult). When you first start the simulation, the rank defaults to Lieutenant j.g. You can select the more difficult levels as you become more proficient. You earn more points for completing a mission at a higher level of difficulty. **See the OPTIONS menu** for more information about ranks and levels of difficulty.

CONTROL Menu

Use the control menu to select or change input device, select sound options and control the detail of the simulation visuals.

Input Device

This determines what device you will use to control your flight. You must select the device **after** selecting your pilot (see page 31). Selecting one of the following five input devices places a check mark next to that option:

Keyboard: This is the default. It allows you to operate the plane entirely from your keyboard.

Recalibrate: Recalibrates the sensitivity of your mouse or joystick.

Mouse: Like the joystick, this allows you to fly and fight the plane with a mouse but leaves several functions to be done on the keyboard. Follow the directions on the screen to calibrate your mouse. To recalibrate the mouse, choose "Recalibrate." The further you move the mouse when instructed to do so, the less sensitive the mouse will be. You can center the mouse by clicking the left button.

Joystick: This allows you to operate the actual piloting and fighting of the plane with a joystick, although you will still have to use the keyboard for several functions. Follow the directions on the screen to calibrate your joystick.

"Place Device in Center Setting" means hold the joystick handle upright (its "at rest" position).

"Range" refers to the maximum distance the stick can be pushed. For calibration, move the stick diagonally to the top right as far as it will go, press the fire button, and then move the stick as far as it will go to the bottom left and press the fire button.

Stick&Throttle: This allows you to use a joystick with a throttle control, such as the CH FlightStick and MaxxYoke. It operates the same as a regular joystick except that the throttle device on the joystick increases and decreases the plane's RPM.

Stick&T&Rudder: This stands for "Stick & Throttle & Rudder" and allows you to use two joysticks (or a joystick and rudder pedals) at

once. The joysticks may be hooked up either through a Y-cable or two game ports. The right stick is for flying the plane and weapon-firing; the left stick (or rudder pedals) is for controlling the throttle in the vertical axis and making rudder turns (see page 29) in the horizontal axis. With pedals, the throttle is on the joystick and the pedals are for rudder turns.

Calibrate the first of these two joysticks normally.

To calibrate the second stick or rudder pedals:

1. Bring the stick directly back (or put the throttle at minimum setting), center it, and press the fire button.
2. Then push the stick to the upper right (or press hard on the fight pedal and set the throttle to maximum) and press the fire button.

Sound Options

- All Sound Off:** Turns all the sound in the game off. Select this for playing at work or when the rest of the family is sleeping.
- Engines Off:** Turns off the sound of the engines, thus relieving a major source of irritation (for real pilots as well as players), and leaving on all the important sounds such as guns and rockets firing.
- All Sound On:** Is for those who have to hear the sound of the engines as well as all the rest of the sound. This is not recommended for households where anyone has sensitive hearing.

Scale Control

- Large Scale:** Makes all the objects in the game four times as big as they normally would be in relation to the land and sea. This is a benefit because it makes spotting things easier.

Detail of Simulation Visuals

- Minimum Detail, Low Detail, Medium Detail, High Detail, and Maximum Detail:** Controls the detail of the simulation. The more detail chosen, the better the detail of the visuals. However, the game runs slower because of the extra time necessary for the computer to draw detailed pictures.

Other Factors

- Engagement Rules:** Turns on the Rules of Engagement, which are described in detail on page 77.
- Bad Weather:** Means that you will be fighting (or perhaps enjoying) bad weather throughout the mission. Some missions are set to "Bad Weather" as a default. The main effect of bad

weather is that it grounds the MiGs. You still have to worry about SAMs and pattern-fired AAA. Please note that there is no bad weather if you are using CGA or Hercules graphics.

OPTIONS Menu

This menu sets your game preferences. For example, you can choose to limit the armaments you have available, to equip your aircraft with "Super Engines," or to make mid-air "Collisions" possible. By manipulating both the **LEVEL** and **OPTIONS** menus, you can achieve a wide range of difficulty levels. For example, you can choose to go up against an aggressive enemy, but retain the advantage of super engines to give you that extra edge.

Choosing an option places a check mark next to it in the menu so you can tell the state of an option at a glance. The following choices are available:

Engines

- Super Engines:** Makes your flying job a little easier. For example, by selecting "Super Engines," you can assume that the ASI (Air Speed indicator) needle is directly connected to the RPM gauge and is the only influence on your speed. The only reason for a stall will be your dropping below minimum speed for the aircraft. This is not necessarily the case with "Normal Engines" (see below).
- Normal Engines:** Makes your flying life a little more difficult. The "Normal Engines" respond to airspeed influences such as differences in air density, whether you are climbing or diving, your current weight, and your current aspect angle. Stalling is much more likely with "Normal Engines" because you do not necessarily know what your TAS (True Air Speed) is.

Armaments

- Limited Arms:** Limits the armaments and ammunition you have available during a mission to the amount the plane could actually carry. This is the more difficult setting and closer to a real-life simulation. Choosing this option a second time toggles it off, giving you an easier game with unlimited arms.
- Limited Chaff & flares:** Limits the chaff and flares you have available during a mission. This is the more difficult setting and closer to a real-life simulation. Choose this option a second time to toggle it off and have unlimited use of chaff and flares.

Flight Model

- Collisions:** If this is turned on, the piloted aircraft is destroyed if it collides with another object (e.g. another aircraft, missile, house, carrier, bridge). Turn "Collisions" off to make the piloted aircraft invulnerable. It can fly through anything

without being damaged. "Collisions" on is the more difficult setting and closer to a real-life simulation. Choosing this option a second time toggles it off.

Ground Crashes: If this is turned on, the piloted aircraft is destroyed if it hits the ground too heavily (during a bad landing, for example). If "Ground Crashes" is turned off, then a heavy landing will not result in the destruction of the aircraft. You can turn "Ground Crashes" off by selecting it a second time.

Red/Black Out: Simulates the possibility of pilot blackout or redout under circumstances of excessive g forces during flight. Positive g forces, usually the result of sharp and climbing high-speed turns, can cram the pilot into his seat and push his blood supply downward. Forces in excess of 8 g's create a risk of pilot blackout, characterized in this simulation by a screen fade-out. Negative g forces, which tend to "pull" the pilot from his seat during a sustained high-speed dive, are equally dangerous. Forces in excess of -2.5 g's can result in pilot redout, characterized by the screen turning progressively red. If either situation should occur in the game, you can recover from it by reversing or stopping the current action by easing off the stick. Turning "Red/Black Out" off avoids this altogether.

Opposition Factors

Enemy Activity: Allows you to choose from "Low," "Medium" and "High Enemy Act(ivity)." These determine whether the enemy's MiGs carry armament, as well as the effectiveness of their flares and the SAMs and AAA. The following table summarizes the relationship between the "Enemy Activity" settings and the effectiveness of the enemy's ordnance.

	MiGs	Flares	SAM & AAA
Low	No guns No missiles	Ineffective	Ineffective
Medium	Guns No missiles	Sometimes effective	Sometimes effective
High	Guns Missiles	Fully effective	Fully effective

Targets: Allows you to choose from "Easy," "Medium" and "Hard Targets." This determines how close the bomb has to be to the target to hit. With "Easy Targets" selected, you score a hit when the bomb falls within an area four times the size of the shape of the target. "Medium Targets" scores a hit if the bomb falls within an area two times the size of the shape. "Hard Targets" must be hit on the target itself.

Fuel

Unlimited Fuel: Means there is no fuel consumption by the plane. You can stay in the air as long as someone doesn't shoot you down.

Half Fuel Use: Means your plane consumes fuel at half its normal rate, giving you much more air time.

Full Fuel Use: Consumes fuel at the regular rate. You have to manage your fuel just like a real pilot does.

indexing Preferences to Rank

The above preferences allow you to tailor the game to your requirements. Your selected rank provides a broad customization. For example, if your selected rank is Captain, the preset options are set for the maximum reality. You can alter them all to "easy," but this gains you nothing, as your score depends on the options selected, not your rank.

The following table shows the relationship between rank and the availability of the "easy" options. The letters in the body of the table refer to the state of the option (Yes/No, Low/Medium/High or Easy/Medium/Hard). The numbers refer to the multipliers to the base score you receive for taking the specified options.

	Lt. ug	Lieut.	Lt. Cmdr.	Cmdr.	Capt.
Super Engines	Y 0.1	Y 0.1	N 0.3	N 0.3	N 0.3
Limited Arms	N 0.1	N 0.1	Y 0.3	Y 0.3	Y 0.3
Limited Chaff/ Flares	N 0.1	N 0.1	Y 0.1	Y 0.3	Y 0.3
Collisions	N 0.1	Y 0.7	Y 0.7	Y 0.7	Y 0.7
Ground Crashes	N 0.1	N 0.1	Y 0.3	Y 0.3	Y 0.3
Red/Blackout	N 0.1	N 0.1	N 0.1	Y 0.4	Y 0.4
Enemy Activity	L 0.2	L 0.4	M 0.4	M 0.4	H 1.4
Targets	E 0.1	E 0.1	M 0.5	H 0.8	H 0.8
Limited Fuel	E 0.1	N 0.3	N 0.3	N 0.5	N 0.5
Totals	1.0	2.0	3.0	4.0	5.0

COMMS Menu

The COMMS menu presents you with three choices. "Single Player" is the default for playing against and with the computer alone. To use one of the other options you must have two computers connected through a null-modem serial cable (available at most computer supply stores). Sorry, we do not support modems because the baud rates of most modems are not fast enough to provide a playable version of this simulation.

Before setting up two-player communications, you must decide on which operation you will fly. Both players should go to that Operation Screen. Then use the COMMS menu to determine which is the "US Host" and which the "Terminal." The player with the faster computer must select "US Host" because his machine does most of the work. "US Host" also has more control of the game and options.

The "Terminal" player may use the menus to pick his own flight mode, level of detail, control method and weather conditions. (Yes, one player can be playing in clear weather and the other in bad weather. This is a gap in reality put in so that one player can play a more difficult game as a personal challenge.)

Single Player: Means you are playing on the computer alone

US Host: Appears as the default when you are playing with or against another player. The player with the faster machine (which will be doing most of the work) should select this line. The host machine is always flying a U.S. plane. This player can choose any aircraft at game beginning. He can switch to any other aircraft including the Terminal player's plane, but he cannot control the Terminal player's plane.

Terminal: Is the option for the player with the slower machine. Once the connection described below is made, he will be presented with the US Host's callsign. Using \uparrow and \downarrow the Terminal player can cycle through all the American callsigns and pick a section to lead on the same mission. Or he can change the callsign number to make himself the Host player's wingman.

If you do not choose an American callsign, you can cycle through Bandit 1, Bandit 2, etc. and pick a North Vietnamese plane to fly. From the outside your plane will look like a MiG, though, of course, the cockpit and handling characteristics will be those of an F-4 Phantom.

Once the Terminal player has picked an aircraft, he must stay in it. It will not fly on autopilot. If it is a U.S. plane, the US Host player can enter it but cannot control it.

If the Terminal player picks a MiG, he must fly with "Collisions," "Normal Engines," "Limited Arms" and "Full Fuel Use" on.

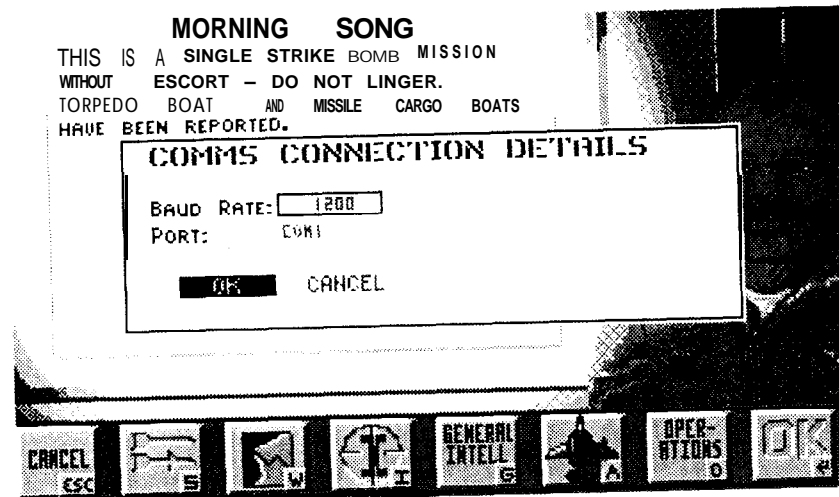

The Comms Connection Details Screen

Once you have finished setting up the mission to your mutual liking, the same screen comes up for both the US Host and the Terminal computer.

- **BAUD RATE** Use \uparrow and \downarrow to select a baud rate. Both players should pick the same baud rate. Try 9600 baud first because the higher the baud rate, the better the game will play.
- **PORT** Use \uparrow and \downarrow to select the port the cable is connected to. Each player picks the port appropriate to his machine.
- **CANCEL** Press ESC to leave this dialog box without attempting a connection.

Once either of the players is shot down, the game is over.

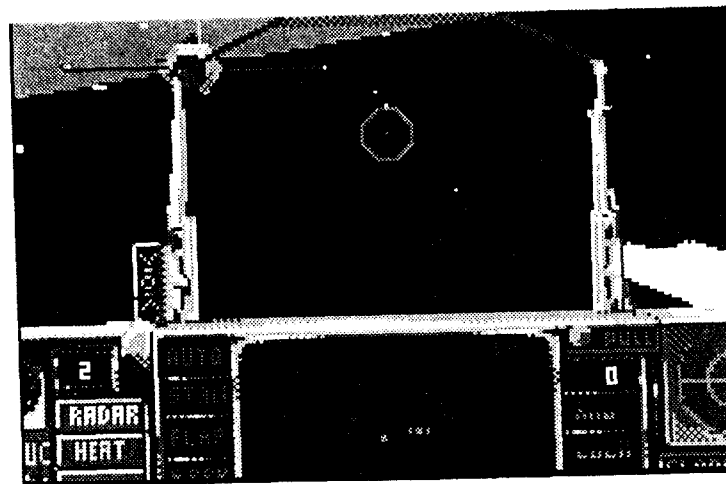

CONTROLLING YOUR AIRCRAFT'

"FLYING WITH THE STICK"

Fighter pilots control the directional movement of their planes with a hand control commonly known as the stick. The accompanying diagrams show how to control your intruder and Phantom using either keyboard, joystick or mouse.

Throughout this manual, references to the stick apply equally to operations using either the keyboard, the mouse or the joystick. For example, "pull back on the stick" means either press the down arrow on the numeric keypad, move the mouse toward you, or move the joystick back toward you, depending on the input device you are using. Refer to the diagrams for the other directional equivalents.

Note: When you use the keyboard to control directional movement, the aircraft's "stick" automatically centers itself after each keypress, allowing you to maintain a constant rate of turn. In other words, if you press **←** once, your aircraft will bank left at a small constant rate and continue to do so until you make another directional change. If you want to increase the degree of turn (or any other directional change), you need to hold the key down for a longer period of time. However, holding the left or right key down will eventually roll the plane all the way over.

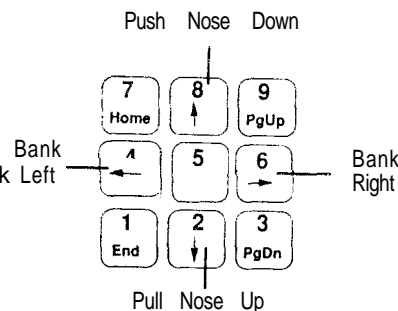

Turns

To make a fast turn, you must hold down both the Bank Left key and the Pull Nose Up key, which puts the plane into a sharp turn. The longer you hold the Pull Nose Up key down, the faster the turn (other things being equal). Things are slightly more complicated when you use the normal (rather than the "super") engines.

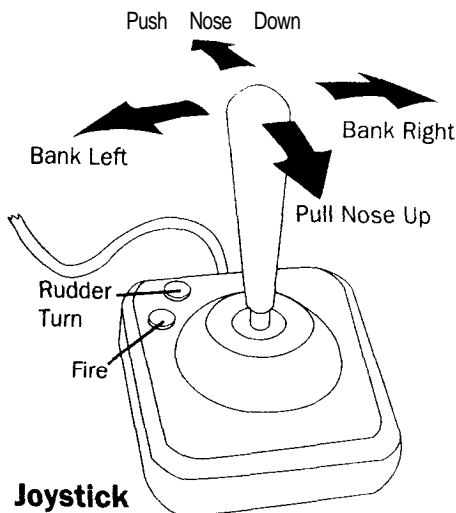

Using the Mouse

If you are flying with a three-button mouse, you can center the stick by pressing the center mouse button. This centers the stick without you having to drag it back to the center position on the HUD (see page 102).

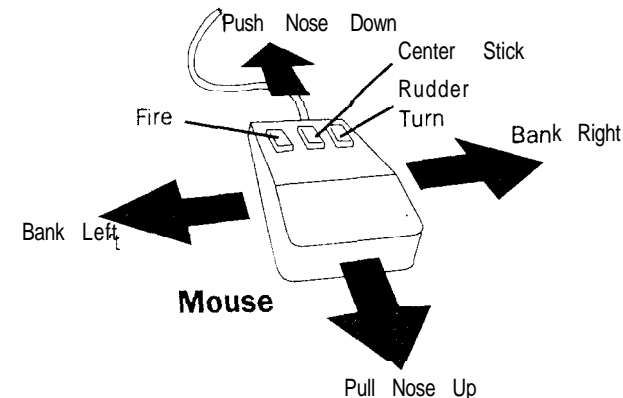

The Rudder Turn

It is possible to make a horizontal turn without moving your wings, making both attack approaches and carrier landings easier. In this simulation, you can even make horizontal turns while banking or inverted.

Input Device	Rudder Turn Technique
Keyboard	Press Ctrl while pressing 4 or 6 on the number pad.
Joystick	Press button 2 while moving the stick to the left or right.
"Stick&T&Rudder"	Move the left joystick horizontally to make rudder turns. Do not move the right stick while doing this.
Mouse	Press the right button while moving the mouse to the left or right.

PAUSE

You can pause the game at any time and put everything into a state of suspended animation. To do this, press **P**. Press it a second time to resume play. Note that this "stops the world." You can go get a cup of coffee or have dinner without worrying about the mission being completed without you. While pausing, you can still move around the different views and different aircraft. The rotation and zoom options (see page 177) also work during a pause.

While paused you can also change weapons and get ready for a bombing run. This simulates the fact that the real A-6 Intruder and F-4 Phantom have a second aircrew member to take care of these details while the pilot flies the plane.

PART III: YOUR FIRST FLIGHT IN THE A-6 INTRUDER

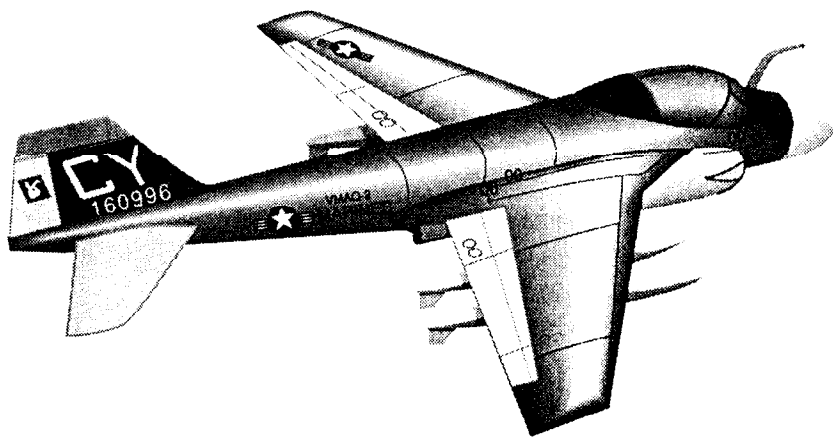

THE DUTY ROSTER

The first thing you need to do is get your name on the Duty Roster. Initially, the Roster just has "Rookie" in every name slot.

- ☛ Select the name at the top of the Duty Roster.

A dialog box appears. This is where you will enter your name and callsign. (The callsign is always used over the air in Vietnam for security reasons. See Part XII: Glossary for some examples.)

- ☛ Press **[Del]** to clear the callsign field and type in your callsign. You can use **[Backspace]** for editing.
- ☛ Highlight the name field and enter your name. Select OK by pressing **[Enter]**.

Back at the Corridor Scene, you are faced with the following options:

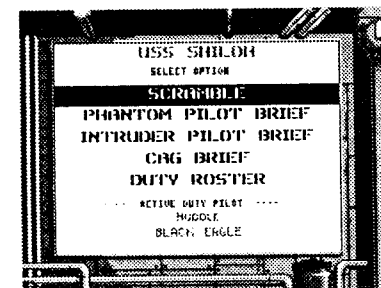

- ☛ Select "Intruder Pilot Brief." You will be moved to the Briefing Room.

The board in the Briefing Room is being used to describe an operation. The icons show the options available to you. In this case we want to choose the "Morning Song" operation, which is the first to appear.

- Select OK by pressing **[Enter]**. If you want to look at other operations first, keep selecting "Next Op" (**[↓]**) until "Morning Song" appears again.

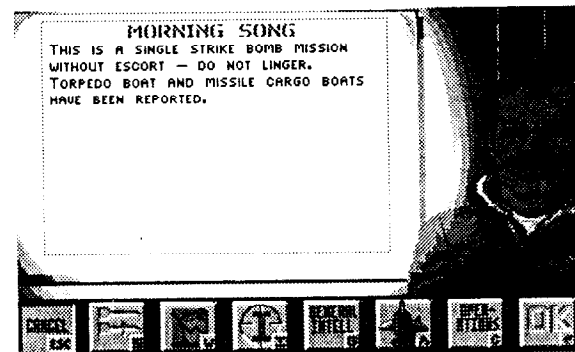

You are presented with a new set of icons (see figure below).



Selecting these new icons provides you with screens showing information about the operation, giving you details about stores, your aircraft, the waypoints, and other relevant data. You can access these screens by pressing the letter associated with the icon (such as the **I** called for below) or by using **Tab** to move the highlight from one icon to the other and then pressing **Spacebar** to select the icon you are highlighting.

Select **I** for information about the Morning Song operation.

The objective of this mission is to destroy a torpedo boat. Nearby barges have been designated as the secondary targets. Unless you are feeling especially skillful, don't bother with these on your first mission.

The torpedo boat is a fairly soft target, and so the Walleye is the ideal weapon. It is a relatively easy weapon to use. (For more information about the Walleye and the other weapons, see Part VIII later in this manual.)

If you like, you can select the other icons to learn more about the operation. Just follow the selection procedure appropriate to your input device. As soon as you are ready to fly your Intruder, select OK from the icons shown at the top of the page.

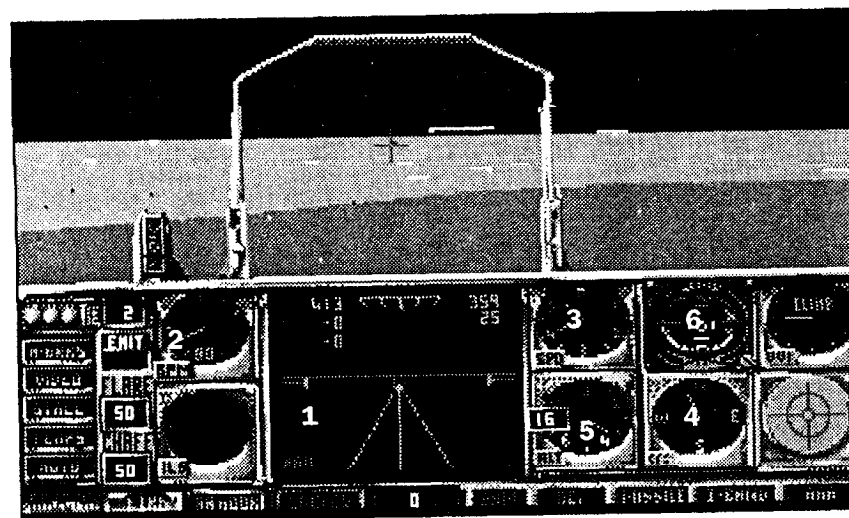
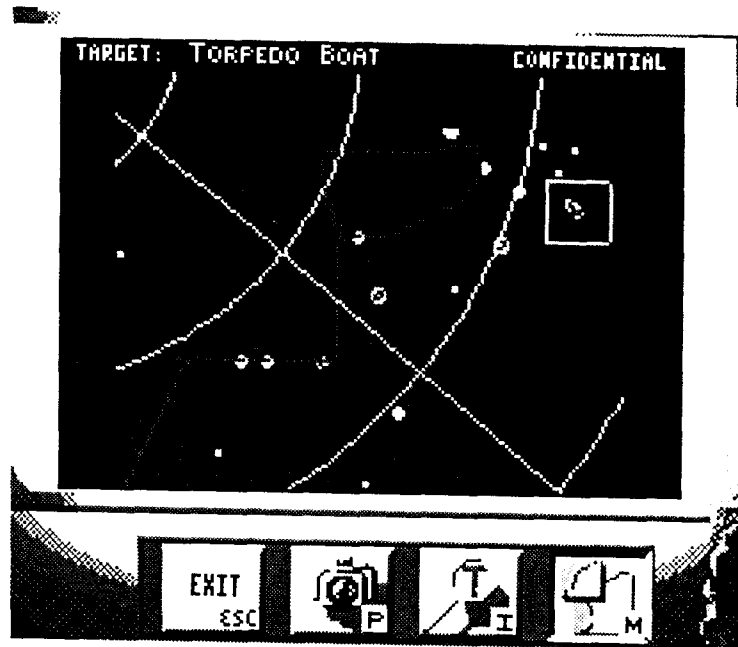

You now find yourself in the cockpit of an Intruder on the catapult.

Cockpit Orientation

Press **P** to pause the game until you finish reading this section.

Take a few moments to familiarize yourself with the Intruder. Look at the components of the cockpit and compare them with the above illustration. You don't need to know what every item represents just now—only the ones you will be using on your first flight. The cockpit and all its components are discussed in detail in the Reference section.

What You Need to Know for Your First Flight:

1. **Combined moving map/radar (COMED).** The radar mode changes depending on the weapon selection and delivery mode. In this first mission we will be using the Walleye missile, so the screen actually shows a TV picture relayed from the missile.

The map is always oriented with north at the top. Your position is represented by a pulsing square on the display. Sometimes a smaller pulsing square is also displayed. This is the position of a MiG referred to by a recent message at the top of the screen. The color of the pulsing square differs with the graphics card you are using for the game.

You can toggle between Radar and Map by pressing **C**.

2. **RPM gauge.** This represents the percentage of power that has been applied with the throttle (**+**) key. The example shows 90% power being applied.
3. **Airspeed dial.** This shows the Intruder's true speed in knots (KTS).
4. **Compass.** This displays the heading. The following table shows the relationship between compass points and degrees from the vertical.

Degrees From Vertical	Compass Point
0 degrees	north
90 degrees	east
180 degrees	south
270 degrees	west

- 5. Altimeter.** This gauge displays the height in feet. The big hand rotates 360 degrees for every 100 feet. The little hand rotates 360 degrees for every 1,000 feet. The digits record the altitude in 1,000s of feet.
- 6. Attitude Director Indicator (ADI).** The ADI helps to orient your aircraft to the horizon while pitching and rolling. Use visual contact with the real horizon to orient the aircraft directionally.

Other Views From Your Cockpit

- Use the combination of the **Shift** and **1, 3, 4, 6, 7, 8** and **9** on the number pad to shift your viewpoint around the cockpit. The position you are looking at corresponds to the key on the number pad with **Shift 8** as the forward view. Thus, **Shift 7** is the left forward view, **Shift 9** is the right forward view, **Shift 4** is the left view. **Shift 6** is the right view, and so forth. This can be duplicated on the normal keyboard pad by using numbers **3** through **9** without the **Shift**. In this case, the keys travel from **3** (left back 45") to **4** (left) all the way around to **9** (right back 45"). This means that **Shift 8** on the number pad is the equivalent of **6** on the keyboard. **Shift 8** and **Shift 9** (or **6** and **7**) give you all the necessary instruments. There are no important instruments in any other portion of the Intruder cockpit.

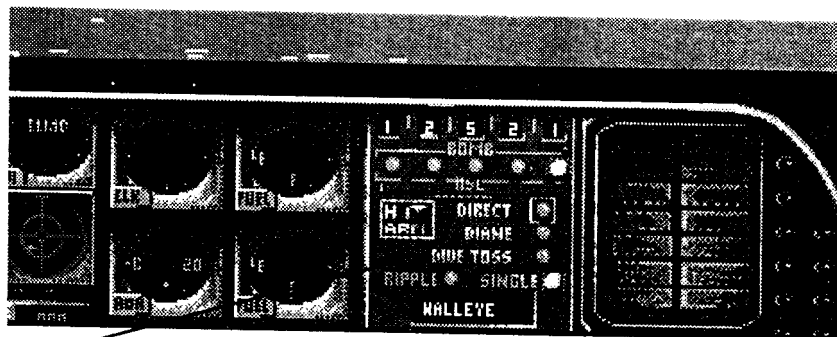

- Go to the right 45" view by pressing **7** or **Shift 9**—you'll learn more about the additional instruments later. For now, note the position of the Multiple Weapon Selection Panel. You'll need this when the time comes to select the Walleye missile.

Even though the other six views do not contain any instruments, you should be looking around all the time during a flight. **Remember that your six o'clock view (directly behind your plane) is your most vulnerable position.** This means that though your six o'clock view does not give you any instrument data, it can show you a bandit on your tail. There is a further complication in that you cannot look directly back because your plane is in the way. You have to use one of the Back 45" positions and weave to see what is on your tail.

- Use **Shift 8** or **6** to return to the front view.

SO LET'S GO ALREADY

OK, OK. So you think you're ready for your first flight? All right, let's go.

TAKEOFF PROCEDURES AND FIRST FLIGHT

- Press **P** again to take the game off Pause.
- You are now under the Catapult officer's orders. When you are ready:
 - Press **Ctrl L** to launch the intruder. If you do not launch within five seconds, you are automatically launched.
- In two seconds you are at the bow of the carrier 60 feet above sea level (SL), doing about 145 KTS. Don't sit back and enjoy the view just yet; you've got work to do. First, you need to put the landing gear away:
 - Press **G** to get the landing gear up. Three lights in a row in the upper left of your control panel will go out and you will hear the sound of the gear retracting.
- Next, you need to start climbing slowly and increasing your speed:
 - Pull back slightly on the stick (see pg. 28) to start a 4,500 ft/min climb. The radar screen gives a digital readout of speed and climb rate in the upper left corner.

You can use ADI rather than WI to monitor your climbing rate. See Part VIII for more information on these instruments.

- At 170 KTS, press **F** to put your flaps up. The "Flap" light on the left side of your control panel will go out.

Next you need to level out a little at about 500 feet:

- At 500 feet, level out by gently pushing the stick forward (see pg. 28). Stop once you are straight and level.

When the ASI shows about 400-450 KTS we climb to our cruising altitude:

- Pull back on the stick (see pg. 28) to achieve a 30" rate of climb. Level out at 10,000 feet and set the throttle to achieve 400-450 KTS True Airspeed. This should require about 86% RPM.

OK, so you're two miles up, and you have to find your way to the target. Remember, you're on a mission. This is a good time to consult the map.

- If the map isn't showing, press **C** to bring it up.

At this stage you can fly on automatic pilot or manually. Autopilot is available because the waypoints to the target have been programmed into the on-board computer. By invoking the autopilot, the computer automatically steers the aircraft to the waypoints in this mission: the carrier, the target (the torpedo boat) and back to the carrier.

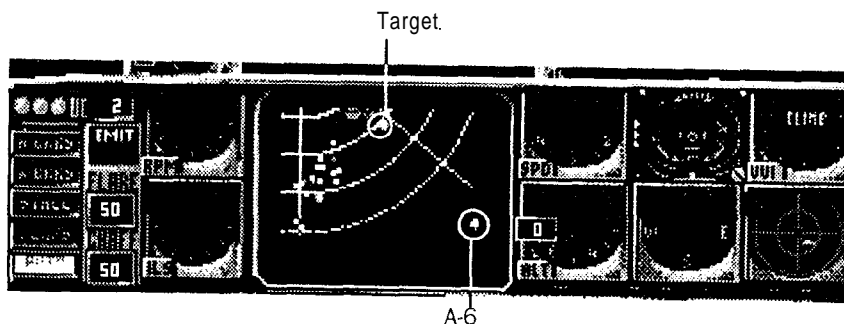

- Press **A** to engage the autopilot

The aircraft should bank and turn towards the first waypoint. This gives you a chance to get used to the aircraft. You can disengage the autopilot by pressing **A** a second time if you wish to experiment with the aircraft controls. To get back on course, press **A** to reengage the autopilot.

If you are still some way from the target, you can press **Tab** to accelerate the action and press **Tab** again just short of the target. The acceleration automatically turns off any time you are being threatened by MiGs or SAMs.

Note that the accelerator key affects all aspects of the operation so that all aircraft are teleported a distance in proportion to their speed. Your wingman goes with you and the MiGs are still after you.

First Strike Mission

Now it's time to select your weapon. As we noted earlier, the torpedo boat is a relatively "soft" target, making it ideal for the Walleye missile. It is "soft" because the boat is lightly armored and just steaming out to sea; it has not yet built up speed.

- Press **7** on the keyboard to go to the Weapon Selection Panel of the A-6. Press **Backspace** to toggle through the air-to-ground weapons to the Walleye missile, and **Home** (the number pad **7**) to arm the missile.

Note for Users of the Tandy 1000

While your keyboard does not have the word "Home" on the number pad **7**, the key still works as **[Home]** for the purposes of this simulation.

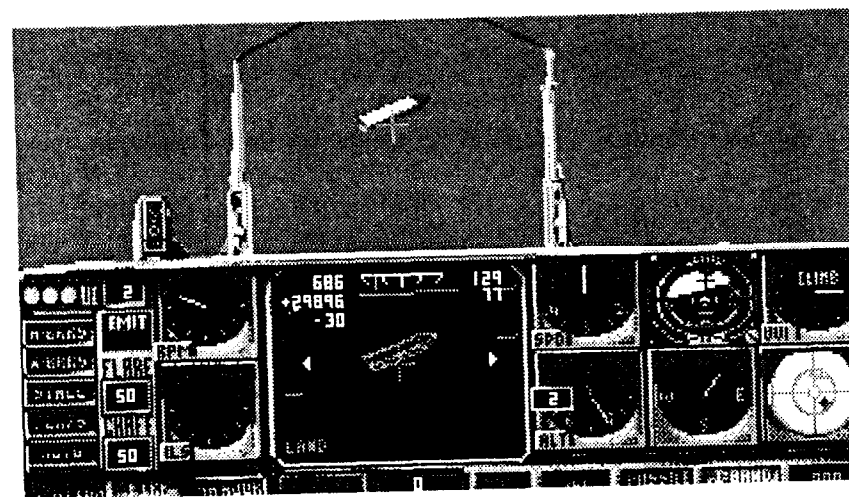

The way is now ready to go. Next you need to target the missile and release it at the right moment:

- Dive at the torpedo boat. The radar will show a TV-like image of the boat. Line up the screen's cross hairs on the image and press **Spacebar** once to lock the missile's radar on the boat. Press **Spacebar** again to fire the missile.

If you were successful in hitting the target, you should see an explosion. If not, better luck next time. In either case, it's time to head back to the carrier before you start running low on fuel or a MiG gets on your tail.

If you're on autopilot, your Intruder should already be heading back to the ship. If not, press **A** to engage it.

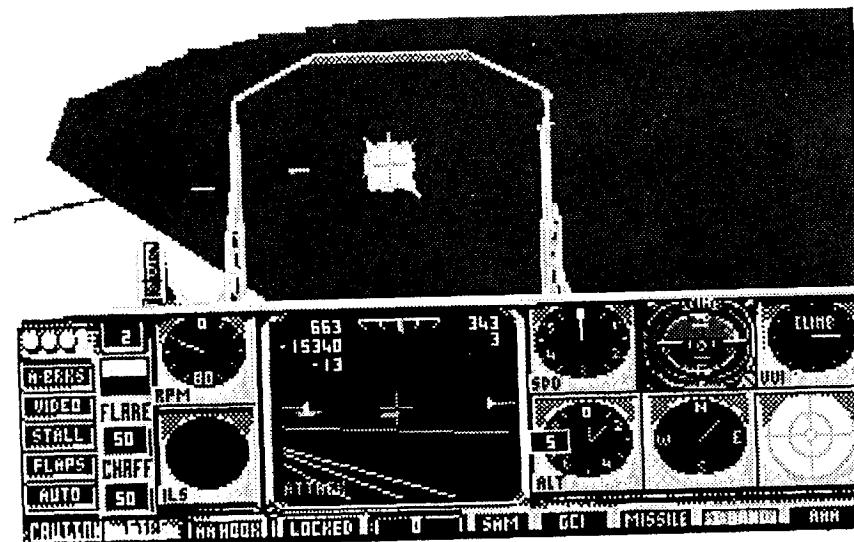

Landing

You may not feel ready to attempt a manual landing at this stage, so try an auto landing by selecting [A]. Alternatively, you can bring up the menu bar by pressing [F10], using [→] to go to the FILE menu, then using [↓] to move the highlight to "End Mission" and selecting it by pressing [Enter]. This takes you directly to the Debriefing Room no matter what stage of the game you're in. Needless to say, this procedure is for the more lily-livered players, those who should have been weeded out at the recruitment office. If you must use it (or if you just want to learn more about menu options), see Part II: Menus and Controls. Consult Part IX: Carrier Landings for information about manual landing.

When your hook has caught the wire and the aircraft has slowed down, you are automatically moved to the Debriefing Room. Look at the TV screen to see how successful you were.

The statistics for the current mission are displayed on the Debriefing Room monitor. The VCR buttons give you the chance to see more detailed results of the mission by pressing [I], a check to see how well you met your waypoints by pressing [W], a chance to review any photographs you took by pressing [P], look at the videotape from your airplane's video recorders by pressing [A], or you can move on to your next mission by pressing [Enter]. See Part VII for information on analyzing these statistics. If you have earned a decoration, you may get pulled out of the debrief at any point for a photo opportunity. A word with your boss comes next; look to see if you are on the Sierra Hotel Notice on his wall. The Sierra Hotel Notice lists the top ten pilots that have played the simulation. The derivation of the term Sierra Hotel is in the Glossary.

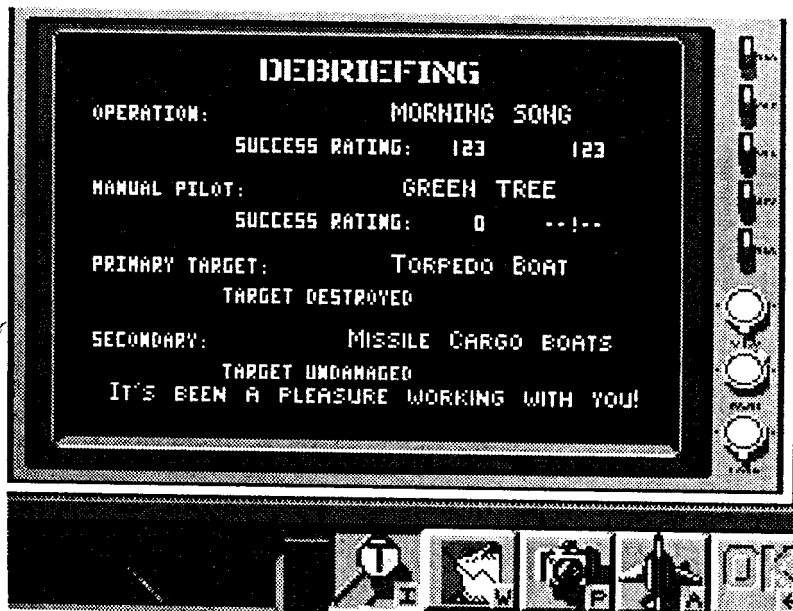

A Typical Intruder Mission

by Lt. Cmdr. Jack McGinn, USNR

It's 0230; you're sound asleep after a tough bombing mission in the North last night. The carrier's been on station for three weeks now in monsoon season and the constant foul-weather flying (ceilings have been averaging 300 ft to 500 ft with visibility often down to 1 to 2 miles in rain) is draining you. The stateroom phone rings; you have to fly a strike in the North again? a high value target. It's time to get your act in full gear. The day has just begun.

After you get the basic details from the duty officer in the Ready Room, you meet your B/N (Bombardier/Navigator) and visit the CV's intel center for the latest information on the target (photos, defenses, restrictions, other planned attacks) and the latest SAM threats affecting the general flight route. The preflight planning includes ingress and egress route selection to take advantage of terrain masking and minimizing enemy defenses, weapons load and release calculations, selection of attack type, briefs on the communications plan, and basic aircraft takeoff planning data.

After preflight planning is complete, you give the duty officer the weight chit which has the aircraft launch weight: the catapult officer and crew need this for your cat launch. Then it is on to your squadron's Maintenance Control space to read the aircraft data book to see what maintenance has been performed and current status of all aircraft systems. After a quick stop in the squadron paraloft to suit up in your flight equipment-G-suit, torso harness, survival vest, helmet, oxygen mask and navigation publications-you check your drinking water before leaving for the flight deck.

It is very dark on the pre-dawn flight deck as rain continues to fall from the low ceiling. Your plane captain briefs you on his inspection of the aircraft. You tell him to keep the canopy closed 'till you and your B/N perform the mandatory pre flight inspection of the aircraft so the seats won't get too wet. It's going to be a long flight so you don't want to sit on a cold, wet ejection seat all flight. After the inspection, you climb in the cockpit and strap yourself into the ejection seat before commencing the aircraft pre-start checklist. Meanwhile, the B/N is going through his pre-start checks. After engine start, he brings the computer system and radar online and begins to enter the turnpoints and waypoints the computer needs for your flight route. After start and post-start checks are completed, you signal you are ready for launch. The Ordies pull your bomb rack safety pins.

Using flashlight wand signals, a taxi director instructs deck crewmen to "break



the aircraft down" (remove its tie down chains). He taxis you forward to bow catapult number 1. As you approach the catapult you acknowledge the "Weight Board" (it has the weight you sent up earlier on the weight chit); he signals you to drop your tailhook (a check to ensure it will come down) and to spread your wings. You lower the flaps and slats, perform your takeoff checklist, and make sure the ejection seat is armed. Following the director's and cat officer's signals, you taxi into the shuttle and are signalled to run up to full power. One last check of the gauges, a good wipe out of all the control surfaces, a "good to go" from your B/N and you turn on your lights as a signal to the cat officer; you're ready to launch. About 2 seconds after he touches the deck with his wand, the cat fires and you go from 0 to 150 K/AS in less than 2 seconds. With a full load of MK82s, that max weight cat shot was a vicious attention-getter in the absolute dark of the predawn clag.

After you clear your head, you have already raised your gear, started a climb straight ahead and accelerated to raise the flaps and slats while the B/N calls the CV to say you're airborne. While executing the departure procedures and checking in with the appropriate airborne controllers, the B/N brings his system to life, providing you with basic navigation information to steer to the coast-in point. Prior to going feet dry, it is time to review the weapon system settings ensuring the proper wing stations are selected and the weapon system is ready to go except for the Master Arm Switch. You've checked that the passive EW system is operational and the active ECM system is in Standby, ready to go. You also take one last look at the chaff, flare and jammer panel to ensure it is ready for pilot activation when the SAMs come up.

It's still black outside as the driving rain beats on the windscreen. Approaching the coast-in point, the B/N turns his radar on for one sweep to update his navigational system. Keeping the radar silent for as long as possible will help to not alert the enemy's defenses. As you prepare to hit your first point, you descend to your preplanned ingress altitude and select the terrain clearance display on your VDI. The B/N is glued to the radar scope as you start to weave your way through the mountains on the route. Being low and masking with the terrain, the SAMs know you're there but they can't get a good lock. The EW indicator is alive with strobes. With the B/N talking from his radar display and you viewing the terrain contours building on the VDI, you weave through the mountains and valleys at 500 ft, 420 K/AS. Your world is the B/N and the VDI.

Nearing the target, a power plant tucked in a valley, you accelerate to 500 K/AS (Knots Indicated Air Speed). You'll need all of the energy you can get for maneuvering when the SAMs start flying. The approach from the initial point (IP) to target was planned to achieve the best target aspect angle and time enough to perform the system attack. About 15 nm out, the B/N selects the Master Arm and tells you the pickle is Hot. You both review the weapons control panel to ensure the proper stations and type of system attack are selected. The plan is to stay low, so you ensure the bombs are set up to drop in the retarded configuration. Drawing closer to the target, the B/N steps the system into attack giving you finer steering information on the VDI. As the weapon solution is reached, the in-range marker comes on the screen telling you to depress the trigger any time.

you pull the trigger, the symbology on the screen jumps and you feel the airplane leap up as the load of 500 pounders falls away. You've never seen the target.

In and out of clouds, tracers start to fly as the enemy now knows where you are.

The B/N is glued to his scope and you to the VDI's terrain display as you jink wildly and fly as low as you can stand, flying the egress route back to the ship.

The B/N gives you heading corrections as you start to get to close to a ridge line building rapidly in front of you. You get a missile launch indication on your EW panel and hear the telltale audio tones as you execute evasive turns to defeat the missile track. You start the chaff program hoping it will decoy the missile. A thundering roar goes off nearby; the missile missed. You deviated off course to evade the missile, the B/N gives commands for a heading to the next turn point. Finally, the EW equipment quiets down and you go "feet wet" and start a climb to head back to "Mother."

The clouds surrounding the aircraft are starting to turn from black to grey as the new day appears. Your Bombardier checks in with Marshal to get the latest weather, marshal radial, and altitude assignment. You're emotionally drained from the gut wrenching low level flight. With the weather at a 300 ft ceiling and 1/2 nm visibility in rain with a pitching deck, you have to dredge up every last ounce of concentration to fly a flawless approach. After getting established in the MC marshal stack and getting assigned your push time, it's time to get ready for the approach. You lower your hook now so you won't forget it later. Fortunately, the ACLS need/es have been working in this bad weather as you test them as OK. Finally, you calculate your landing weight and optimum approach speed and get rid of any excess gas so you can trap aboard with the proper weight.

It's your turn to push out of the stack and start your approach. You hear the approach controllers vectoring a low fuel state Phantom to the duty tanker and another just bolstered. It doesn't sound like it is going to be easy. Passing through 5,000 ft at 250 K/AS you break your rate-of-descent and continue to 1,200 ft where you level off and drive in. At 10 nm the controller tells you to delay lowering your landing gear till 8 nm. At 8 nm you go dirty by lowering the gear, flaps, and slats and start to slow up to 150 K/AS while performing your landing checklist. At 6 nm you put the speed brakes out and start slowing up to your on-speed air-speed. You continue to fly the TACAN final bearing course to the point you hope to get need/es.

The controller, who hasn't talked to you except to acknowledge you are on his net and that call at 10 nm, comes up at 4 nm to say he's sending you ACLS information and to "call your need/es." You've been working hard to follow the final bearing in as best as possible so you can get a good start on the approach. You call the need/es as centered and slightly high. That's OK because you are approaching the glidepath from below. The controller says to fly your need/es. It's still raining heavily as the rain pelts the windscreen. You keep the need/es centered and keep your instrument scan going so you don't lose track of AOA, altitude, or lineup. You remember lineup especially. You saw your squadron CO and pilot land too far right one night. clip a few planes then disappear forever in the water.

It's now a mile to go to the CV and you're concentrating in the cockpit. The B/N says he can't see anything yet. If you don't see anything soon, you'll have to execute a missed approach and try again. At 34 nm the controller says "Intruder 506, 34 nm, call the ball" as he hands you off to the LSO for the visual portion of the carrier approach. You tell the LSO, "Intruder 506 is Clara" which means you can't see the ball. He says, "Roger, Paddles contact, keep it coming, you're looking good, a little power." Suddenly the B/N sees the ship just as you do. You have to make a slight lineup correction to the left but the ball is solid in the datums. Suddenly you touch down and cobb the throttles then feel that reassuring tug of the wire. As you clean up and taxi out of the landing area, you breathe again. You're emotionally exhausted. After shutdown and debrief it's time for breakfast and your second flight of the day.

Welcome to the world of *the All Weather Attack Pilot*.

Jack McGinn has been a Naval Aviator since 1979 and has piloted A-6E s and A6E TRAMS with the VA-75 "Sunday Punchers." He has 1,850 hours in the A-E and has had 300 traps. He is now in the Naval Reserves with Tactical Air Control Squadron 24 and is the owner of an aerospace consulting company in Norfolk, Virginia.

Finishing the Mission

You can move through the screens that follow by selecting OK each time. This will take you back to the Corridor Scene, ready for your next operation. Selecting "Scramble" gives you a repeat of the previous mission. You could try a more adventurous Intruder mission if you like, but you're probably itching to climb aboard an F-4 Phantom. If so, just go to the next page.

PART IV: YOUR FIRST FLIGHT IN THE F-4 PHANTOM

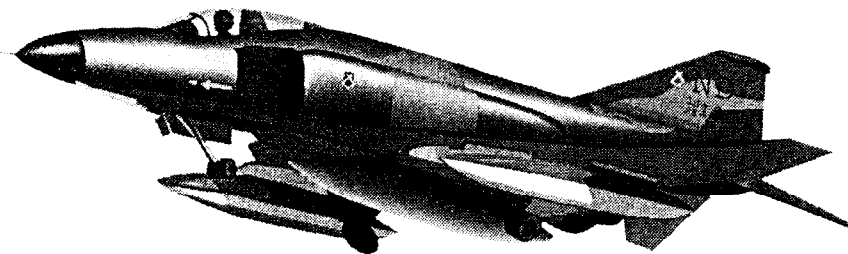

"It was heavy. It proved the aerodynamic principle that if you have enough power, you can fly a brick.. "

"It had honest flight characteristics. it was a very stable gun platform, albeit with no gun. And I never thought I'd admit it, but in the end, I came to love the airplane.. "

Both quotes from Col. Dennis J. (Dee) Kiley,
U.S. Marine Corps.

SELECTING A PHANTOM MISSION

You have just completed your first Intruder mission and are back at the Corridor Scene. You have the following options:

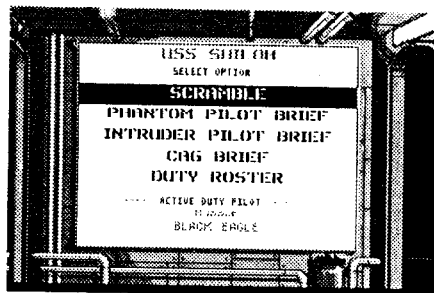

- Select "Phantom Pilot Brief" and then select "BarCAP" by pressing **Enter**. If you want to look at other operations first, keep selecting "Next Op" (**↓**) until "BarCAP" appears again. Press **Enter** twice.

You will then find yourself on the catapult ready for an immediate launch to intercept an incoming air threat. Your wingman will be launched seconds behind you. This will be your opportunity to practice wing tactics.

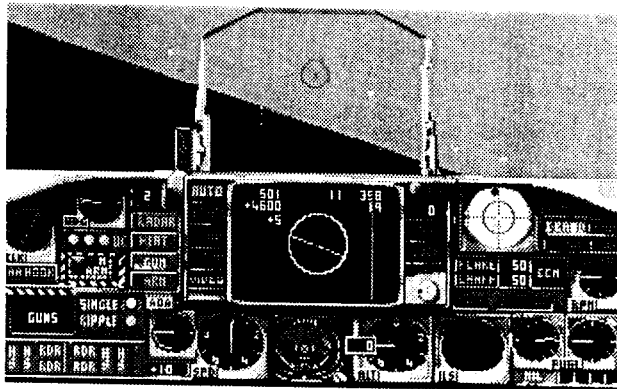

Cockpit Orientation

You will probably notice some similarities between this and the A-6 cockpit. More important, however, are the following differences:

The F-4 has a four-stage fuel afterburner (AB). Select **→** to increase, **←** to decrease. Use full AB during the launch. You can also use AB to go faster.

Unlike the A-6, the cockpit views are symmetrical, so that the right forward 45° view looks out of the aircraft. This is because the F-4 pilot and his RIO (Radar Intercept Officer) are placed in tandem, with the RIO behind the pilot. In the A-6, the pilot and his B/N (Bombardier/Navigator) are effectively side-by-side.

There is also a look down view. Press **↓**, and note the position of the Multiple Weapon Selection Panel to the lower left. Press **↑** to get back to the usual cockpit view.

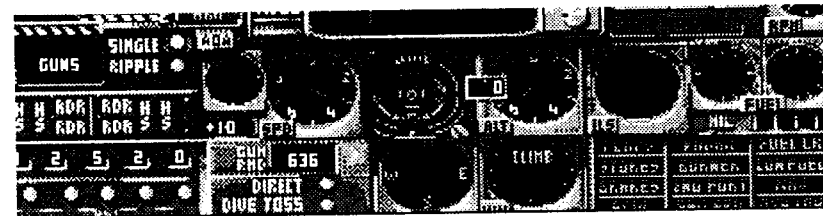

TAKEOFF PROCEDURES AND FIRST FLIGHT

Controlling Your Aircraft

Input device controls are the same as the A-6. Takeoff and landing procedures are also similar, except for the use of the afterburner on takeoff. You may want to review the earlier section describing aircraft control on pages 28-29.

About the BarCAP Mission

You will be vectored to incoming threats by Red Crown, the radar picket ship. Stay in the air as long as you want (at your beginning level you have unlimited fuel and weapons). If you try this mission using the "Limited Fuel" or "Limited Arms" options from the **OPTIONS** menu (see Part II), you will have to return when you are Bingo fuel (just enough fuel for a safe landing) or Winchester (out of missiles and ammunition). Otherwise, when you are tired of dogfighting, see pages 49-50 for instructions on how to get back to your carrier and receive the rewards you have earned for your efforts.

When you are ready to take off:

- Press **Ctrl L** to launch the Phantom or wait for automatic launch.

Note that afterburner uses fuel at a tremendous rate, so cut back as soon as possible. Don't sit at sea level with full afterburner.

- Follow the same procedures as you used with the Intruder to climb to 1,000 feet. Kick up your speed to 600 KTS. You will note that your *RPMs never get below 70%. If an F-4s RPMs get lower, it falls, so a throttle stop is built into the engine to prevent this.*

Within seconds you are at 1,000 feet and following your patrol pattern. Now it is time to look for bogeys (unidentified aircraft) that might threaten your home carrier. In Vietnam, the North Vietnamese wisely refrained from attacking American aircraft carriers in international waters. This made BARCAP a very dull duty for Navy fighter pilots. For this game, however, MiGs attacking the carrier are a very real threat. Keep your eyes open.

- Look for the enemy by following the directions printed across the top of your screen. Remember, that 12 o'clock is directly in front of you and

6 o'clock is directly behind you. You want to have enemies in the former position and do not want them in the latter position. See pages 63-64 for instructions on how to follow the directions from Red Crown.

- At a distance of less than 27 miles, it is possible to get radar detection of your enemies if they are within a 60° cone from the nose of your plane. If your radar is on (select **[R]** if not) and you are pointing at the MiG, you should get a green blip on the radar screen. However, this means that the MiG will detect your presence easily.

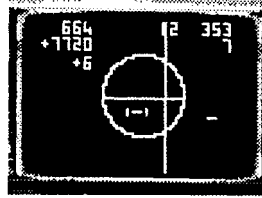

- Also, you get a black diamond on the threat indicator (the circular screen on the upper right of the control panel) if the MiG has its radar turned on. (For this beginners game, all MiGs have their radar on.) This screen also shows other aircraft, ships and radar stations that illuminated your plane with their radar. The range for this passive radar screen is variable, between 15 and 30 miles.



- Finally, if all else fails, look for your targets. You can see enemy aircraft about eight miles away. Actively switch to different viewpoints within the cockpit. Like the A-6, you cannot look directly back over your tail; your RIO is in the way. Do not shoot at your wingman.

Going Into Combat

- Select **[I]** to get the look down view.

This gives you a view similar to what you would get if you kept most of your attention inside the cockpit. You want the Multiple Weapon Selection Panel on the bottom left of this view.

- Use **[Return]** to toggle between the Sparrow and Sidewinder missiles and your 20mm gun.

As you toggle through the weapons you should see one of the rows of five horizontal lights illuminated when the Sidewinder is selected. This represents the selected station on the Phantom's wing or centerline. Note that this is the position (station) on the wing, not the type of weapon. This means that you might toggle the same type of weapon several times in a row if the weapon is carried on several stations. The guns and Sparrows do not light up because the guns pod is internal and the Sparrows are mounted on their own special stations.



The weapon type is displayed in text in the box over the station representation.

Above the illuminated station light you will see the number of weapons available in that station. Above this set of numbers you will see some lights labeled

"RDR" (indicating how many radar-guided (Sparrow) missiles) and "HS" (indicating how many heat-seeking (Sidewinder) missiles). Gun rounds remaining are shown to the right of the Multiple Weapon Selection Panel.

Use the Sparrow for targets more than two miles away, the Sidewinder for targets you are behind that are within two miles, and the gun for targets within 500 yards.

Using the Sparrow

The AIM-7 Sparrow is a radar-guided missile, so using it is a matter of getting a radar lock on the target.

- Toggle **[Enter]** until AIM 7 appears in the display box, the Radar light comes on in the menu to the left of the radar screen, and a green cone circle appears on the radar screen.

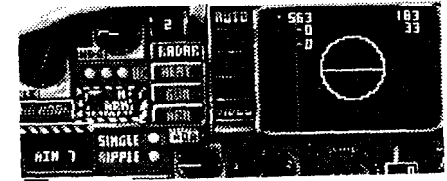

- Steer to keep the green blip inside the inner green circle. The range figure (lowest right number on the radar screen) will continue to count down the range. When you are within

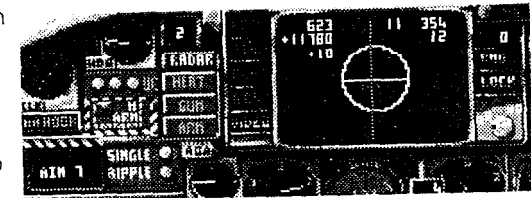

Sparrow range (2-14 miles) the RNG (range) light to the right of the radar screen comes on. If you have been keeping the target within the green circle, the LOCK light should come on soon after. Two vertical lines on either side of the blip also appear when lock has been achieved. These lines are called "captain's bars."

Be sure to check your threat indicator when you get these captain's bars. Your radar might have locked on to your wingman. The radar locks on to the closest target every time you turn it on with the **[R]**. If you keep locking on to your wingman, change your position relative to the potential targets or find a target somewhere where your wingman isn't.

If your threat indicator shows two enemies (solid diamonds) and no friendlies (empty diamonds) and the radar shows three possible targets, it is possible that your wingman does not have his radar on. Use **[Shift][9]** to go to your wingman's cockpit and turn on his radar with **[R]** so you can see him on your threat indicator and get a better idea who you are locked onto.

- Switch on the Master Arm (select **[Home]**) when the MiG is in range and fire when the LOCK light comes on. The Sparrow will guide to the target as long as you keep the target blip in the captain's bars until it hits.

Sparrows are the weapon the Phantom was designed to carry. The Sparrow had not been used in combat before the Vietnam War and had a very low PK (Probability of Kill). Only one out of twelve fired hit a target. Launch two Sparrows at the same time to increase your chance of success.

If you launch without a lock-on, a hit is unlikely. However, launching in these conditions is not always foolish. At least a launch may unsettle the bandit. This can be important if the bandit has you or another friendly in his sights.

NOTES: In this mission, you have a little easier time of it than the Navy had. The missile's PK has been greatly improved. If you select a harder level (see Part II), you will have the same problems the Navy did.

Using the Sidewinder

The AIM-9 Sidewinder is a heat-seeking missile whose descendants are still being used today.

- Select the Sidewinder by toggling (Enter) until AIM 9 appears in the weapons box, the Heat light comes on in the menu to the left of the radar screen, and a green cone circle appears on the radar screen.

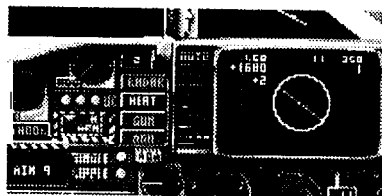

- Find your target in the same manner you used for the Sparrow. When the target is within Sidewinder range (1-2 miles), point at the enemy's rear so the heatseeker head on the Sidewinder can find its target.

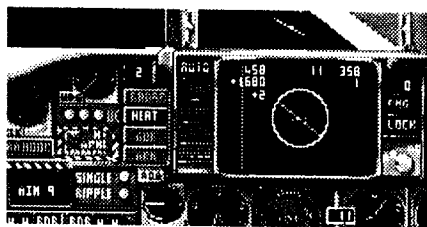

Select **[Home]** to master arm your weapons and use **[Spacebar]** to launch missiles at the target. If you are having trouble getting every thing done on time, remember that you can press **[P]** to pause the game and press the necessary setup buttons, and then unpaue the game before pressing **[Spacebar]**. The Sidewinder is normally a "fire and forget" weapon so you do not need to point at the target after missile release.

Sidewinders also had a low PK in Vletnam, though not as bad as the Sparrow. Among their problems was they were not the all-aspect weapon they are now. The pilot had to be on the tail of the target so the heat sensors in the missile could get a good thermal picture of its exhaust.

NOTES: For ease of play, the default "easy targets" selection on the **OPTIONS menu** allows you to shoot at any aspect of the target with a fair chance of success. The "medium targets" option requires you to shoot at the bandit's rear quarter to get a lock. The "hard targets" option requires that you continue to point at the bandit's rear while the missile is in flight.

Using the Vulcan M61A1 20mm Cannon

The Navy never intended for the Phantom to carry a gun and, even after the need for guns became obvious, never really liked mounting guns on their Phantoms. The original design called for an entirely missile-armed plane, and only the U.S. Air Force mounted the internal 20mm provided in this game. F-4J's, the type of Phantom being flown here, did have an optional externally mounted 20mm gun pod, however, so we are using that as an excuse to give you lots of opportunity to shoot up the opposition. If you insist on doing things The Navy Way, never select "GUNS" in your dogfights.

Only a few Navy F-4s actually carried the external pod, and it was strictly meant as an air-to-ground weapon. It was very inaccurate for air-to-air use.

- Select guns by pressing either **[Enter]** or **[Backspace]** (you can use **[Backspace]** because guns can also be used against ground targets) until GUNS comes up on the display box and the GUN light comes on.

Guns should only be selected when the target is in visible range. For initial detection, use the same methods you use for missile targets.

- Use **[Home]** to switch on the Master Arm when the target is within a mile and fire (using **[Spacebar]**) when ready.

For best results, do not shoot until the bandit fills your screen. The bandit should at least be bigger than the sighting circle. Remember that you and the bandit are moving. You need to use what is called deflection shooting (or just "leading a target"), which simply means you have to shoot where the enemy is going to be, not where he is when you press the trigger.

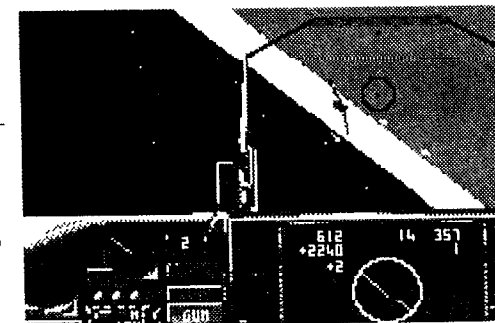

NOTES: More than one hit is needed to kill a MiG. Successful hits are marked by mini-explosions on the surface of the MiG.

After the Battle

Once all the bandits have been shot down, you should head back to the ship. For most missions, once the mission has been accomplished you can press **[F5]** to go to the outside view and press **[J]** until the Waypoint readout says "4 LAND." Then press **[A]** to engage the autopilot to take you directly back to the ship. For the BarCAP mission, however, you should use the **FILE menu** to select "End Mission" as shown on the next page.

LANDING

You may not feel ready to attempt a manual landing at this stage, so try an auto landing by selecting **A** and settling back to watch the landing. If you do feel like bringing the plane in yourself, see Part IX: Carrier Landings (page 137). Alternatively, you can bring up the menu bar by pressing **F10** and selecting "End Mission." This takes you directly to the Debriefing Room no matter what stage of the game you're in. Needless to say, this procedure is for the more lily-livered players, those who should have been weeded out at the recruitment office. If you must use it (or if you just want to learn more about menu options), see Part II: Menu.

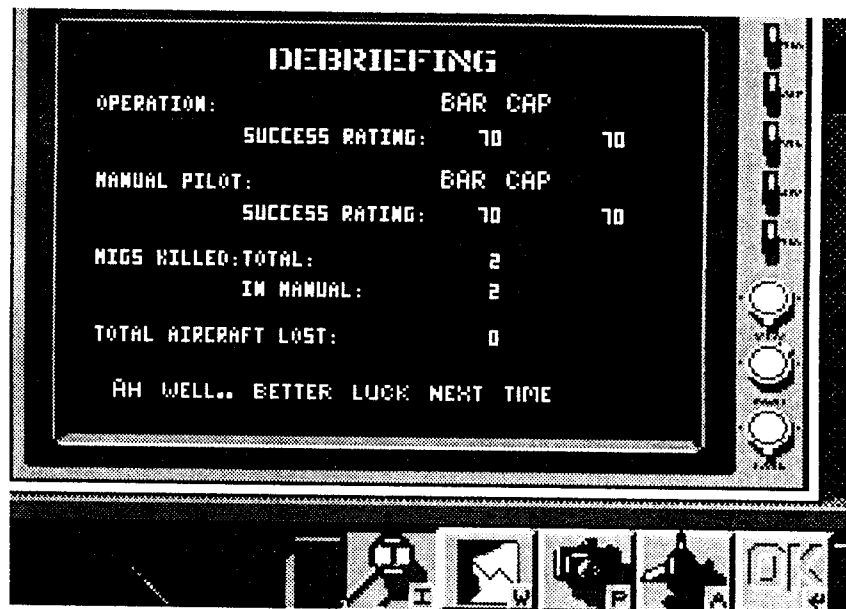

When your hook has caught the wire and the aircraft has slowed down, you are automatically moved to the Debriefing Room.

The statistics for the current mission are on display in the Debriefing Room. See Part VII for information on analyzing these statistics. If you have earned a medal or badge, you may get pulled out of the debrief at any time for a photo opportunity. A word with your boss comes next; look to see if you are on the Sierra Hotel Notice on his wall. The Sierra Hotel Notice lists the top ten pilots that have played the simulation. The derivation of the term Sierra Hotel is in the Glossary.

You can move through the screens that follow by selecting OK each time. This will take you back to the Corridor Scene, ready for your next operation. Selecting "Scramble" gives you a repeat of the previous mission.

Flying The F-4

by Col. Phil Handley, U.S. Air Force (ret.)



On a cloudless day in August 1984, at Holloman AFB, I flew my last flight as an active duty TAC pilot. That flight was made in the magnificent F-15 *Eagle*, a plane I had flown and loved since 1977. Its flawless handling qualities are transferred through a hydro-mechanical stick that makes it feel smaller in your hand than the comparatively tiny F-5E. On my second ride in it at Luke AFB in 1977, I did a triple Immelmann—a vulgar display of brute power. Its huge bubble canopy affords the pilot an unrestricted view of his 6 o'clock, an attribute that had been sacrificed by aero design engineers since the era of the F-86 Sabre. However, as much as I loved the F-15, to this day, absolutely nothing stirs my memory banks or brings chills to my spine like the crack and roar of an F-4's afterburners on takeoff roll.

First of all, it looks like a fighter ought to look with its dropped nose and stabs-canted wing tips, and no-nonsense "don't mess around with me" stance. Anybody looking at the business end of this fighter (especially an enemy) has got to immediately understand the purpose for which it was built. When the Thunderbirds and the Blue Angels flew them in their demonstration teams, the ground shook, babies cried, and dogs barked. They were never better, and it was a sad day when the Thunderbirds were forced to trade them in for T-38s (which looked and sounded like a Tinkertoy by comparison). But as great as it was in air shows, it was far more impressive doing the job it was designed for, a fact indisputably demonstrated for over seven years during thousands of sorties in the skies over Southeast Asia (SEA).

The All-Around Fighter

Officially named the Phantom II, but affectionately called "Double Ugly" or the "McDonnell Rhinoceros" by the men who flew her, the F-4 will surely join great fighters of the past like the Spitfire, P-51 and F-86 as a classic. It was and continues to be a big, rough, mean-faced fighting machine that doesn't do a single thing better than competing fighters. Thuds (F-105s) were faster and far more stable bombing platforms, F-5s and all the MiGs could out-turn it, its out-of-cockpit visibility wasn't that great, the original models were built without a gun, it was plagued with tremendous adverse yaw, and the engines smoked so badly at mil power that a defecting MIG pilot once stated that the first time he ever saw one he thought it was on fire. But as a package deal, the F-4 could do it &—Close Air Support, interdiction, air superiority of reconnaissance. It was simply the best fighter in the skies over North Vietnam.

As a "mud beater" it hauled a lot of iron very far, very fast. It could fight its way in and out of the target area, and with two of the most reliable engines in the

world (seemingly immune to throttle abuse and FOD), it would bring you home, even with one of them shot out.

Unarmed and Unafraid

The RF-4C was a recce version, it carried high speed cameras instead of weapons and had the thorny mission of post-strike reconnaissance. After a huge strike package (called the eight hundred pound gorilla) had done its thing and really gotten everyone north of the Red River stirred up, somebody had to go in and get the pictures—a job that fell to the particularly gutsy and resourceful aircrews that flew the RF-4C. Their motto, "Alone, Unarmed, and Unafraid," wasn't always totally accurate. On many occasions "alone" didn't apply because it was decided that an element of armed F-4s should accompany them into the just-vacated target area to protect them from MiG attack while they were getting the pictures. These missions were appropriately called "The Run For The Roses," because to a recce pilot, speed was life; the RF-4C was fast-boy, was it fast. Since it was lighter to begin with, and had far less drag than its accompanying missile-laden escorts, it was not uncommon for the flight leader of the escort to find himself in first or second stage afterburner by the time the recce hit mil power. When he really got serious and went to full burner, he would simply walk away from his escort like it was parked and the escort would find themselves all alone directly over the "City On The River" as the unarmed recce disappeared at supersonic speed into the foothills.

Fighting MiGs

In the air-to-air role, all versions of the Air Force's F-4 C, D, and E bristled with eight missiles and a gun (only the F-4E carried the gun internally). Although the missiles didn't work that well, no one else's did, either. Even if their PK was low, AIM-7s launched at long ranges left huge white exhaust trails that created great confusion, loss of tactical awareness and mutual support within the MiG formations.

The Phantom had energy to burn (especially in the dense air at low altitude), and in the hands of a capable pilot, it was more than a match for all takers.

Against the much lower wing-loaded MiGs (especially the MiG-17 and MiG-19), you simply could not play a "nose-pointing" game anywhere near the MiG's corner velocity, as you would constantly find him pointing at you with his nose on fire. Conversely, the F-4 could take the flight into the vertical where it enjoyed a decided energy advantage, or drag it low into the dense air where it not only had unbelievable energy, but where the MiG pilot's flight controls became stiff and his airframe unstable at very high calibrated airspeeds. Against a cannon-only armed MiG-17 or MiG-19, an F-4 pilot could "unload to zero G" and extend to a range that allowed him to "pitch back" into the fight with great energy and a better aspect angle.

Taking the fight into the vertical became a classic tactic, but by no means did it ensure victory. In the hands of a skilled pilot, all of the MiGs (including the MiG-17) could take it up with you. When this happened, you had to avoid being

"spit out" in the ensuing vertical rolling scissors before the MiG ran out of energy and fell off. This maneuver was especially dangerous against the MiG-21. It not only turned well, but also had the energy to go up with you a long way. Once a vertical rolling scissors was joined, it was somewhat like "riding a hog; there was no way to get off." Even if it meant flying the bird down to zero air-speed, you had to do whatever was necessary to make him fall off first. If you failed and tried to extend out of the fight, not only was the MiG-21 difficult to extend from, the F-4's forty-foot afterburner cones made a great heat source for his Atoll missiles.

The Controversial Guy In Back

Originally developed for the Navy, the F-4 was non-traditional in that it was a two seat fighter. The thinking being that there was more than enough for the pilot to do in flying the jet without having to also run the fire control system. The Navy assigned these tasks to the backseater, calling him a R/O (Radar Intercept Officer). The Air Force, using their rule ensuring nothing was ever called the same as in the Navy, dubbed their backseater the WSO (Weapon Systems Officer). Those that flew the Air Force F-4s took it one step further and simply called him the GIB (Guy in Back). Few tactical fighter controversies rival the continuing debate over single seat vs. two-place cockpits, where strong and passionate arguments are advanced all the way from the Pentagon to the stag bar. Everyone has an opinion, and having flown both single seat and two-place for a number of years, I am no exception.

Flying by yourself in today's fighters like the F-15, F-16, and F/A-18 works just fine. Not only does it make you feel macho, but your individual situational awareness and ability to act decisively is probably heightened. I have no empirical data to support that assertion, it's just how I feel.

However, I don't think the single seat would have worked worth a damn in Southeast Asia. For one thing, the avionics and weapons systems, although not nearly as capable as today's, were difficult to operate really well. HOTAS (Hands On Throttle And Stick) was non-existent. Clearing your own six o'clock from the F-4's cockpit was difficult during patrol, and almost impossible once engaged in a close-in fight. Simply put, the F-4 was designed to exploit the state-of-the-art weapons systems of its day, and those systems did not easily lend themselves to operation by an single individual.

In my opinion, if the GIB did nothing more than twist himself around to put his eyeballs on your vulnerable cone during dogfights, he was worth his weight in gold. But the truth of the matter is that he did infinitely more than that. I have flown with lots of them, some better than others, but I was privileged to fly most of my missions in SEA with two really great ones. They could pick radar returns of MiGs from the clutter of a radar scope that looked to me like a bowl of butter-milk. They could air refuel off tankers, and generally fly the jet better from the back seat than some of the IPs. (Some GIBs saved their pilot's life when they recovered the aircraft after he was incapacitated.) Contrary to myth, they weren't all frustrated pilots that couldn't hack it, but dedicated professionals that

strapped their pink bodies to Double Vg/y and did their jobs four feet in trail with you, in one of the most sophisticated and dangerous integrated air defense environments ever devised. One of those GIBs I refer to was killed in action; the other won the ATC Commander's Trophy in flight training, was top gun at F-4 RTU and F-15 RTU, and will soon be a general officer. As whether future fighters should be single or two seater, I could make arguments either way. But in the case of the F-4, you will not hear this fighter pilot bad-mouth the GIB.

Carrying On

To this day, the F-4 continues to be a great fighter. In the active duty forces, the RF-4C is still the primary recce aircraft for TAC, USAF and PACAF. The F-4G, a highly modified version of the slatted F-4E, performs the Wild Weasel role of detection, identification and destruction or suppression of enemy radars. Although no F-4C's are still in service, hundreds of F-4D and F-4E models have been constantly updated and scrupulously maintained by Air Force Reserve and Air National Guard units, where they are flown exceedingly well by highly experienced and capable aircrews.

Not bad for an aircraft designed in the mid-1950s. But time marches on, and one day, like all of the great ones, it too will pass from the scene. When it does, I for one sincerely hope that it will take its place on a pedestal of honor at TAC Headquarters at Langley AFB (even if it was originally a Navy design), for it has served us exceedingly well and has truly earned its place in the sun.

Colonel Phil Handley was a U.S. Air Force command pilot with 7,000 flying hours and two combat tours in Southeast Asia (325 combat sorties) flying F-4D's and F-4E's. He earned 21 Air Medals, 3 Distinguished Flying Crosses, 1 Silver Star and is the only Phantom pilot to shoot down a MiG-19 with guns.

Moving On

Now you are a veteran of two operations, Morning Song and BarCAP. If you think you are ready to take on the duties of the Commander Air Group (CAG) and plan your own operation, turn the page to the next section. If you feel you need a little more combat experience, go back and try another mission or two flying either an Intruder or a Phantom. Return to the main corridor and select either "Intruder Pilot Brief" or "Phantom Pilot Brief." You are taken to the Briefing Room, where you can select from the available operations.

As described in Part V: You As CAG following, it is possible to modify any of these missions by changing their waypoints or the aircraft taken.

PART V: . YOU AS CAG

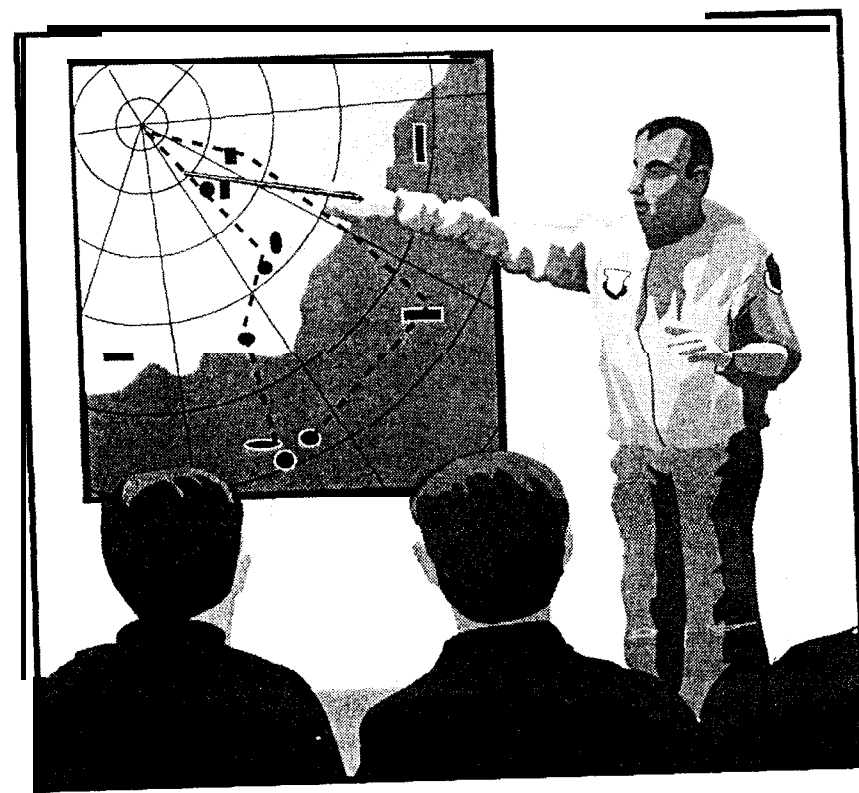

PLANNING A MISSION

You have successfully undertaken at least one of the two preceding missions, and now you feel ready to plan and execute your first operation as Commander Air Group. You are at the Corridor Scene. (If you're not, you should know how to get there by now). As usual, you have the following options:



➤ Select "CAG Brief."

You are taken to the CAG Briefing Room, where the display shows a list of the primary targets.

Summary of the Mission Planning Process

Planning an operation is a multiple stage process. First, the CAG selects the operation's primary and secondary targets. Primary targets are usually significant installations, such as a bridge, a railroad or an ammunition dump. A primary target is the whole point of the operation-hitting a primary target is sufficient to make an operation a success. Secondary targets are targets in the vicinity of the primary but are less important. You can get extra points for hitting a secondary target. Note, however, that all auto-flying in this simulation is based on single pass attacks. This means that if you are on autopilot, you will be taken over the primary target and then back to the carrier.

The next step in planning an operation involves choosing the waypoints and setting up the desired route, timing and actions.

The route should be chosen to keep planes coming into the target ("ingressing") from running into planes leaving the target ("egressing").

The timing should involve in what order planes leave the carrier and in what order they hit the target area. Usually the bombers launch first and then the MiGCAP and other escorts go. They are faster than the bombers and arrive over the target first. In general, Iron Hand and Wild Weasel attacks should hit their targets before the main bombing run happens, but not so far in advance of the bombing attack that the enemy has the time to recover and be ready for the next attack. Leave at least a minute between sections taking off.

Actions involves which planes handle which parts of the job: which planes are handling Iron Hand, which planes are doing the bombing, and so forth.

Most screens described in this part can be accessed if you have chosen "Intruder Pilot Brief" or "Phantom Pilot Brief," but you cannot alter any planning element unless you arrive at the screen by selecting "CAG Brief."

A MISSION OF YOUR OWN

Let's set up a mission to see how this works.

➤ Select "Hanoi Power Station" as your primary target and select "OK."

You will then be presented with a list of secondary targets.

➤ Select "SAM site near Hanoi" as your secondary target and select "OK."

This brings up the main CAG screen, which presents you with the following choices:

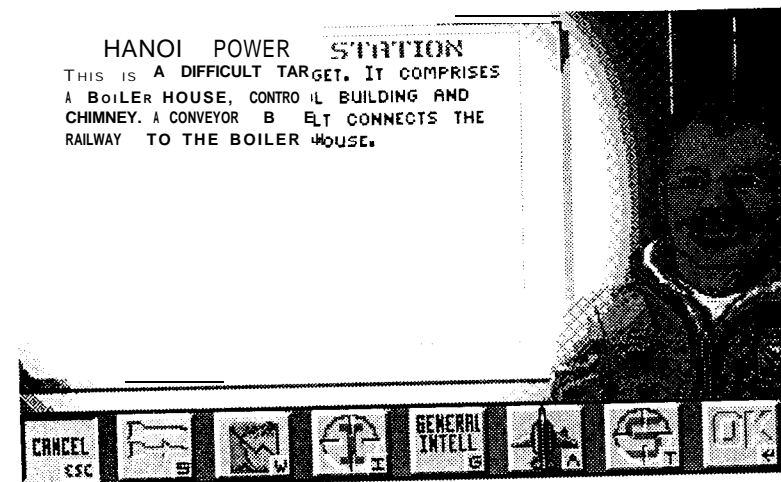

- | | |
|-------------------------------|--|
| Esc Cancel | Return to Corridor Scene. |
| S Stores | Choose weapons and other external stores. |
| W Waypoint | Set up the desired route, timing and actions. |
| I Target Intelligence | Obtain information about the chosen target. |
| G General Intelligence | Obtain information about selected area of map, e.g. position, SAM, MiG, AAA and ground force activity. |
| A Aircraft Info | Obtain information about your assigned aircraft and set up departure times and duties. |
| T Target Select | Choose another primary target. |
| Enter OK | Accept changes and continue. |

Saving the Planned Mission

To save your finalized mission, press **T** to go to the Target Screen, then **S** for "Save." You can enter your name for the mission in the dialog box

You can choose your options in any order you like. For example, you can set your waypoints and then decide you want to select a new target (which would

require resetting the waypoints). Or you can get aircraft information, and then decide on the weapons and external stores. Generally, however, it's a good idea to obtain General and Target Intelligence before making your other choices, since what you learn from them may influence your decisions. The first one to look at is Target Intelligence.

TARGET INTELLIGENCE

Select "Target Intelligence" by pressing **I**.

This information is provided to help the pilot locate and identify the target. On entry, a map is displayed showing the primary and secondary targets. Get this information first; without it, you won't know where to send your attacking force,

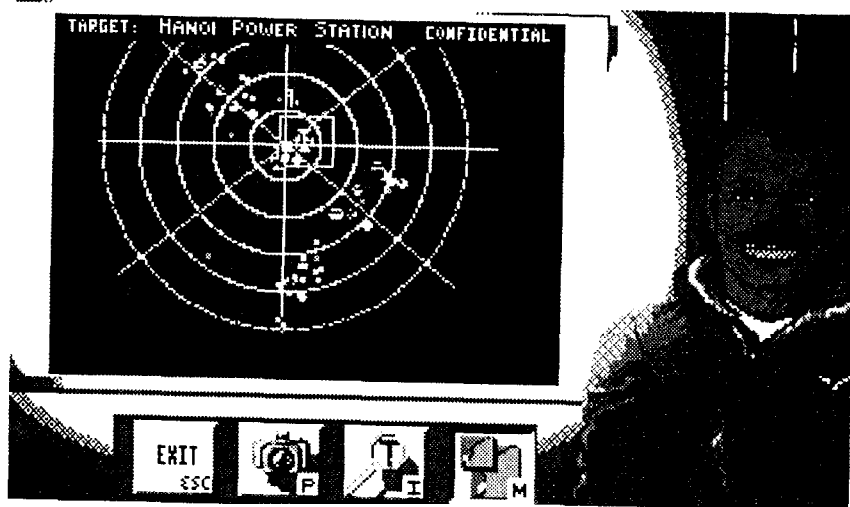

- Esc** **Cancel** Returns to Mission Planning Screen.
- P** **Photo** Shows digitized picture of the target.
- I** **Information** Describes position and description of the target.
- M** **Map** Changes the scale of the map display between the general map of North Vietnam and the location of the target. The target location map also puts a square around the target site.

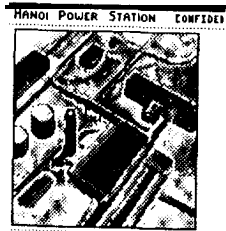

Now you know where you are going. It's time to look at the General Intelligence Map to see what you are going to be up against.

GENERAL INTELLIGENCE

When planning, you will need to know something about the enemy activity. This is where you get the latest intelligence. It should be possible to plan a route that skirts the heaviest defenses. Don't go to Hanoi via Haiphong Docks. Remember the long way around could use too much fuel.

You can use GI aggressively. Make a note of the annoying SAMs/AAAs, and hit them on the way back from the main mission.

Select "General Intelligence" by pressing **G**.

This gives you a map similar to the Target Intelligence map, with the following icons available:

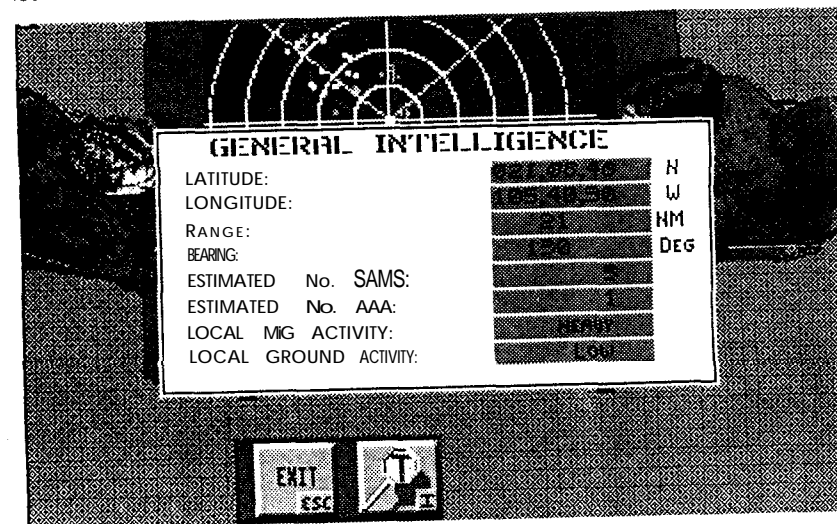

- Esc** **Exit** Returns to next level up.
- I** **Information** Displays the following intelligence about the area enclosed in the square:

Position:	The latitude and longitude
Range:	Distance in miles from Hanoi Bull's-eye (see next page)
Bearing:	Compass bearing from Hanoi Bulls-eye
Estimated No. of SAMs:	How many SAMs in the area
Estimated No. of AAA:	How many AAA in the area
Local MIG Activity:	How likely MiGs are to be present*
Local Ground Activity:	How likely that moving ground targets (trucks, tanks, boats) are present*

* In both these cases, the range runs from low (hardly any) to heavy (lots).

POINTS OF INTEREST

The activity in this game is concentrated in the following area:

19 deg N to 22 deg N
104 deg E to 108 deg E

Within these boundaries was Pac Six, the heaviest defended area in North Vietnam. It is possible to fly outside this region but it is not very interesting since we have not defined anything outside this region. The area is bordered on the east and southeast by water. To the north and northwest is China; venturing here is foolhardy-expect to be shot down very soon. To the west and southwest are the mountains of Laos, another hostile area.

There are five maps available in the software.

The Overall Map: A small scale map of the whole area wntcn is displayed during waypoint editing in the game beginning. Because the whole area is displayed, the map can be used for route planning. This map is also used for the moving map display in the aircraft cockpit.

This map is similar to the authentic Route Map included with this game. This Route Map is identical to the maps carried on the knees of pilots who flew over Vietnam.

The Detail Maps: Four other maps at four times the scale of the small scale map can be displayed during waypoint editing. The maps display the most targeted areas:

Hanoi:	20-55N to 21-40N	105-30E to 106-30E
Haiphong:	20-15N to 21-00N	106-00E to 107-00E
Yen Bai:	21-15N to 22-00N	104-30E to 105-30E
Than Hoa:	19-30N to 20-15N	105-00E to 106-00E

If an area you want to zoom in on is not within these boundaries, you cannot zoom in on it.

When looking at locations on the Waypoint and Intelligence maps, the locations are given in degrees of latitude and longitude. However, for an easily understood location fix in combat, we also use the "Bull's-eye system" used by the Air Force and Navy in the Vietnam War. Bull's-eye is downtown Hanoi. Any position in North Vietnam can be described as a bearing and range from Bull's eye. The COMED shows these coordinates. The circles are drawn in 20 nautical mile increments from the center of Hanoi.

So MiGs at 180 for 60" means that MiGs have been sighted 60 miles south of Hanoi. Looking at the enclosed route map, you can tell that the MiG is at about 20", 2' N by 105", 49' E, or just south and west of Bien Son.

WAYPOINTS

Next we'll choose the waypoints for the operation.

Select "Waypoint" by pressing **[W]**.

This brings up the following screen:

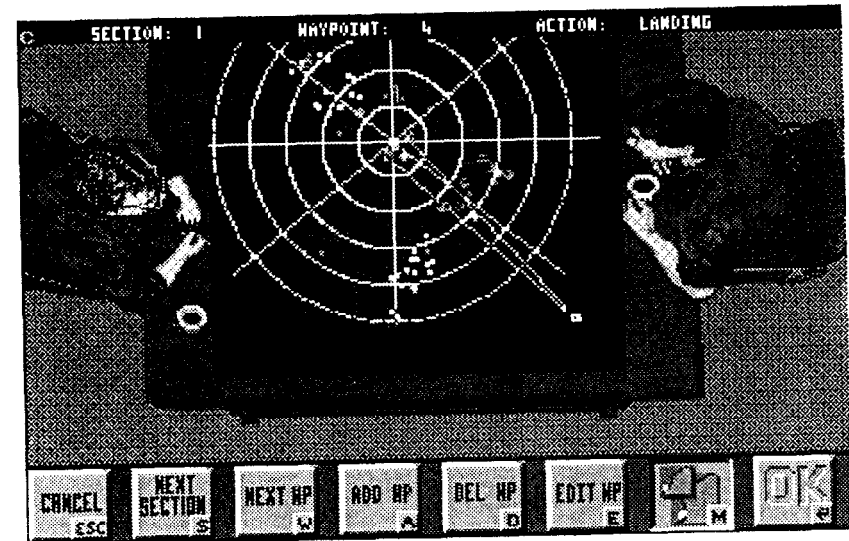

After selecting waypoints, a map is shown on which is displayed the route and waypoints for the first section of aircraft. Note that a route is specified for the section, not individual aircraft. The current waypoint is flashing. The current section, waypoint number and waypoint action are displayed at the top of the screen. There must be a minimum of four waypoints, and the first and last are treated in a special way-i.e., they cannot be deleted or edited.

To set the waypoints for your operation you use the following icons:

- | | |
|--------------------------|---|
| [Esc] Cancel | Returns to CAG Screen and forget edits. |
| [S] Next Section | Displays next section's route and waypoints. |
| [W] Next Waypoint | Makes next waypoint current. |
| [A] Add Waypoint | Adds a waypoint after the current waypoint. This is not allowed for the last waypoint. |
| [D] Del Waypoint | Deletes current waypoint. |
| [E] Edit Waypoint | Opens dialog box to edit waypoint (see next page). |
| [M] Map | Changes to larger scale map. The current waypoint must be retained on the map; therefore, moving to the large scale is only allowed if that point is available on the larger scale map (see page 60). |
| [Enter] OK | Returns to CAG Screen with edits made. |

Moving the Position of the Current Waypoint

Cursor Keys: Press **←**, **→**, **↑** and **↓** to move whichever waypoint has been selected with **[W]**.

Mouse: Click the left mouse button to select the nearest waypoint. Drag the waypoint and release to set it.

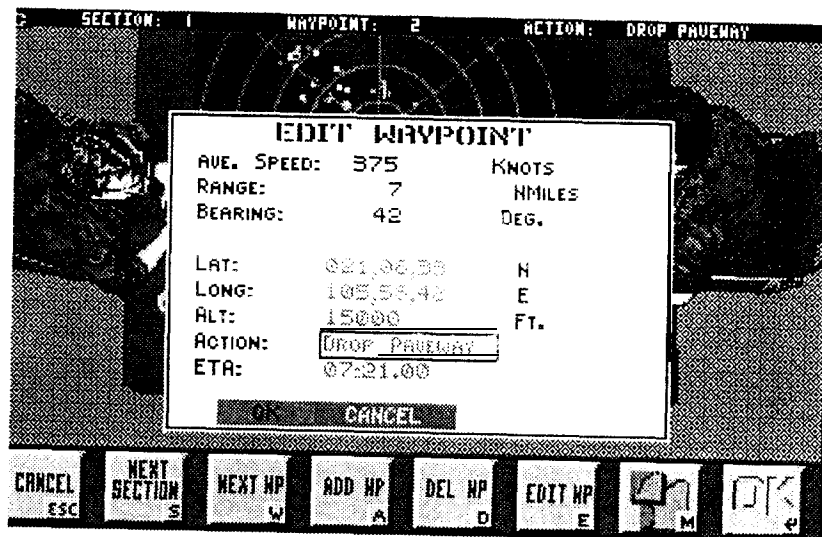

Editing Waypoint Dialog

This is divided into two areas. The first is the Comment Field: it tells you what your average speed should be and the range and bearing of the point to Bull's-eye (see previous page). These entries change when you change the fields described below. Also, if your new entries take the waypoint out of the range of the map or to an impossible latitude or longitude, a message telling you so appears when you attempt to leave this screen by pressing **[Enter]**.

Latitude/ Longitude: These entries allow you very accurate placement of the current waypoint.

Alt: This shows the altitude at which the section of planes should reach the waypoint.

Action: This allows you to set up the specific operation for each waypoint and let the mission unfold automatically. "Take-off" and "Land" are always the first and last actions. The others are described on the next page.

ETA: The Estimated Time of Arrival is the time that you want the aircraft to reach the waypoint. This can only be successfully altered from the aircrew menu (page 70).

No matter what ETA you set for missions such as CAP, Iron Hand and Wild Weasel, the sections on those missions do not withdraw until the bombing or strike section reaches its last waypoint on the way to the carrier. It is the function of these sections to protect the main section, and they fulfill their duty.

The Waypoint Actions

There are several actions you can command for your sections.

Circle: Use for any action that involves the plane hanging around an area and looking for targets. This includes fighters on CAP of any kind and F-4s and A-6s assigned to Iron Hand and Wild Weasel.

Ripple Bombs: Drop iron bombs on the target.*

Drop Paveway: Drop a Paveway guided bomb on the target.*

Fire Walleye: Fire a Walleye missile at the target.*

Jink: Trazevi using lots of hard turns to throw off AAA and SAMs.

No Jink: Travel in as straight a line as possible.

Combat Form: Travel in side-by-side loose formation to give you more freedom of action in case of a dogfight.

Cruise Form: Travel with the wingman tucked in behind and to the right of the leader to give the smallest target to radar.

Land: Land on the carrier.

Weave: The wingman is behind the leader weaving from side to side to inspect the section's six.

* Descriptions of these weapons are on pp. 132-136.

If you are looking at the waypoints shown with **[F5]**, **[F6]**, **[F8]** and **[F9]**, you can get some other "waypoints" by pressing **[Shift]**.

Buddy: This gives you the offset (number of degrees) from your current bearing and miles to your wingman.

Carrier: This gives you the offset (number of degrees) from your current bearing and miles to your carrier.

Next Waypoint: This is the default setting, and tells you what function you are to perform at the next waypoint when you reach it. These terms are simplified versions of those shown above.

Navigate: Refers to any noncombat action.

Attack: Refers to combat actions ("Circle" or one of the specific bombing actions shown above).

USING THE ENCLOSED MAP

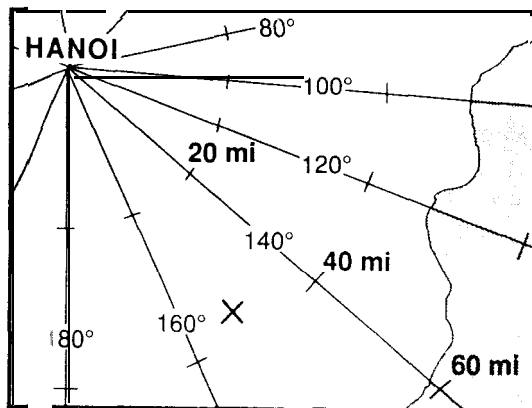

Enclosed with this game is a copy of an actual mission map used by an Air Force pilot over Vietnam. The objectives and map in this game were based on the original of this map.

Important on this map is the northern Bull's-eye, centered on Hanoi. See page 60 for a full explanation of how this is used. In the illustration to the left, the "X," which represents a Bandit, is 153 degrees from Hanoi and about 38

miles away (each tick mark is 20 nautical miles). Red Crown would call this as "Bandit, 153 at 38."

Remember that messages from Red Crown give you the absolute compass bearing of the bandit as reckoned from Bull's-eye. Do not confuse this with the bearing of your target or waypoint as given on your radar screen (page 107). The bearing on your screen is a relative bearing. It assumes the current heading of your plane is *always* 0° (zero) and tells you how many degrees the bearing to the target or waypoint is away from that heading.

For example, if you are 50 miles from Hanoi in an F-4 and heading straight for Hanoi on the 153° line, the above bandit will show up on your radar at 0° and 12 miles. Alternately, if you are Jake Grafton flying 70 miles directly east of Hanoi and proceeding toward your waypoint over that city, the radar screen shows a bearing of 0° (instead of your compass bearing of 270°) and a distance of 70 miles to your waypoint.



Similarly, the bearings to your waypoints and the carrier (see page 63) are bearings relative to your plane. If you change the waypoint to "Carrier," the bearing information is telling you how far off a direct line to the carrier you are.

For example, if the "Carrier" shows as having a bearing of 90°, it is directly to your right. If you bank right, the bearing will change until it reaches 0°, which means the bearing to the carrier is the same as your aircraft's heading. If you follow that line of direction without deviation, you will eventually get a bearing reading of 180° because you have flown over the carrier and it is now behind you.

STORES

Now that you know where you are going, you need to determine what you are going to deliver to the target.

Select "Stores" by pressing **S**.

This brings up a screen depicting either an F-4 Phantom or an A-6 Intruder.

The CAG chooses weapons and other external stores, such as extra gas tanks and ECM pods. It is important to choose the right weapons for the job. Forego the extra missiles if the trip is a long one, lighten the plane or take an extra gas tank instead.

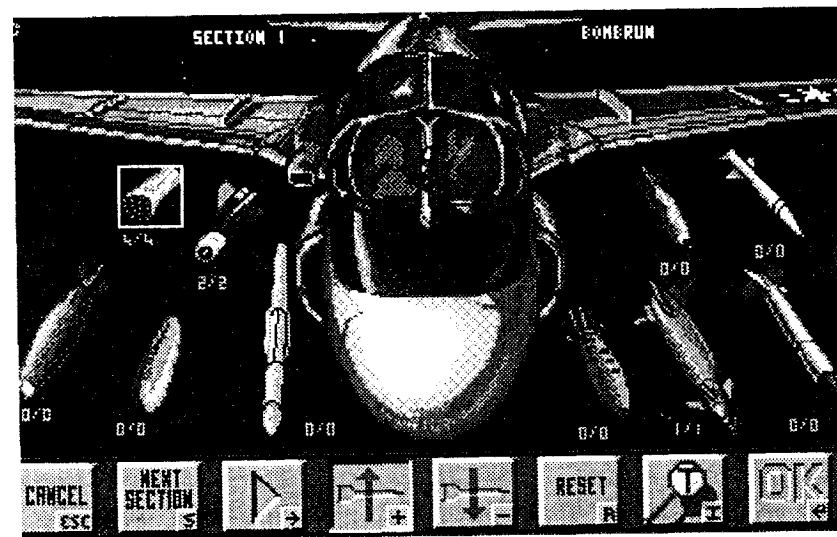

Description of Icons:

- S Next Section** Moves to the next section of planes attached to the operation.
- Next Weapon** Highlights the next weapon to the right. Pressing **←** will move the highlight to the left, even though there is no icon displayed.
- Load** Loads highlighted weapon. If there is room on the center station, then the weapons are loaded individually. If not, the wing stations are used and the weapons are loaded in pairs.
- Unload** Unloads highlighted weapon. Center stations are emptied first.
- Reset** Resets the weapon selection to the standard load for type of mission selected. In CAG mode, the reset is to a basic minimum bombing load of Walleye and MK82s.

I Information

Provides information about how and when to use the highlighted weapon. Next to each weapon a fraction is displayed. The top number indicates the number of that weapon type currently loaded. The bottom number represents the total number that could be loaded. Note that as weapons are loaded, the options become more limited.

Section number and duty are displayed at the top of the screen.

- For our mission, select a Paveway from the stores screen by moving the selection square to it with and then selecting it with .

Optional External Fuel Tanks

For some missions extra fuel is essential-if you are using "Limited Fuel Use" and "Normal Engines." However, double-check those fuel management calculations to make sure you don't have too much fuel. Unnecessary fuel tanks can cause you to handle sluggishly and lessen your possible weapon load. Too much can be as bad as too little!

The possible extra tanks are:

370 gallon fuel tank	Only for use with the Phantom
300 gallon fuel tank	Only for use with the Intruder, this is a small external fuel tank always loaded in pairs which gives a total extra capacity of 4200 lb
600 gallon fuel tank	Only for use with the Phantom, this is a large external fuel tank holding 4200 lb of extra fuel

Weapon Station Capacity

The underside and wings of both the Phantom and the Intruder have areas where weapons can be slung for use. These are called weapon stations. The following tables show the capacities of the two planes.

RO	Right outer wing
RI	Right inner wing
Center	Under the body of the plane
LI	Left inner wing
LO	Left outer wing

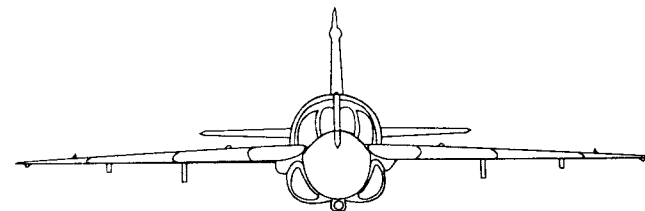
**Intruder**

	Wt (lbs)	Stations				
		RO	RI	Center	LI	LO
300g fuel	330+2090	1	1		1	1
ECM Pods	1100	1	1	1	1	1
Shrike	453	1	1	0	1	1
Walleye	1104	1	1	0	1	1
MK82 Snakeye	559	6	5	6	5	6
MK82	497	6	5	6	5	6
MK83	999	3	2	3	2	3
MK84	1995	1	1	1	1	1
Paveway	1995	1	1	0	1	1
Rockets	427	3	2	0	2	3

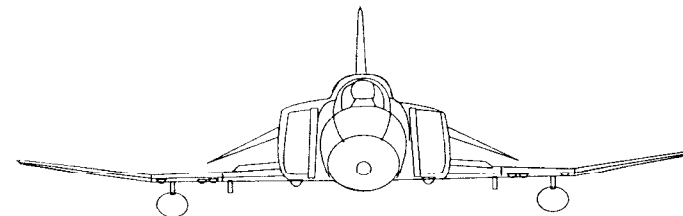
**Phantom**

	Wt (lbs)	Stations				
		RO	RI	Center	LI	LO
370g fuel	330+2585	1	0	1	0	1
600g fuel	440+4190	0	0	1	0	0
ECM Pods	1100	0	1	0	1	0
Sparrow	453	0	2	0	2	0
Sidewinder	169	0	2	0	2	0
Shrike	453	1	1	0	1	1
Walleye	1104	1	1	0	1	1
MK82 Snakeye	559	6	3	6	3	6
MK82	497	6	3	6	3	6
MK83	999	3	2	3	2	3
MK84	1995	1	0	1	0	1
Paveway	1995	1	1	0	1	1
Rockets	427	5	0	5	0	5

AIRCRAFT INFORMATION

Next, we'll need to obtain information about the aircraft you'll be using in the mission.

From the CAG Screen, press to get the Aircraft Information Screen.

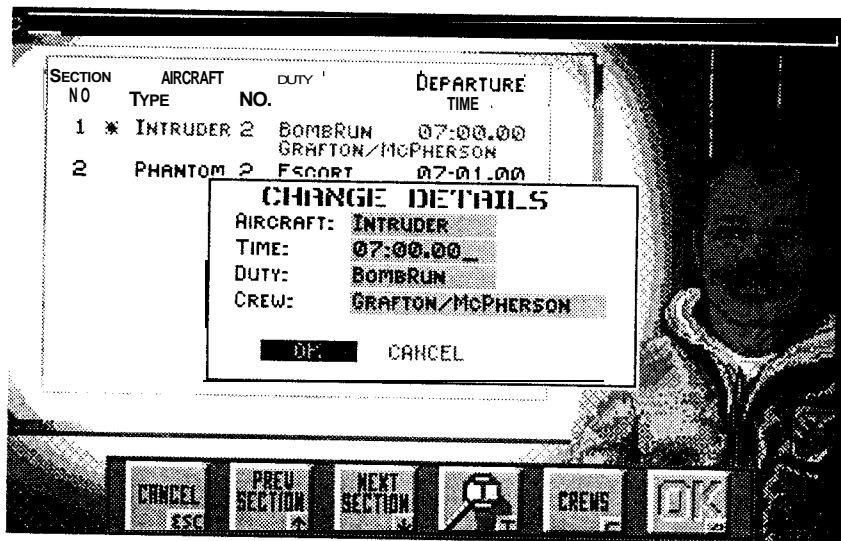

This is where you get the information about the aircraft in the chosen operation. The aircraft fly in sections of one or two aircraft for mutual protection. Most sections start with two members, leader and wingman. The exception to this is the lone Intruder mission that goes in low and fast in bad weather. Sections never consist of a mix of aircraft.

Each section is given a number. This is important as it is used to move between the sections when in flight; you press for Section 1 and so on. This simulation has a limit of four sections per mission.

As well as displaying section number, aircraft type and number of aircraft in the section, this screen also shows duty, departure time and the aircrew of the lead aircraft. The duty dictates the type of job given to the section. This is explained later. If you want to alter the time of departure, this is the place to do it by moving the cursor with or to the "Time" line and editing the entry.

The aircrew information line gives the names of the pilot and B/N (or RIO) for the lead aircraft in each section. Pressing gives you the ratings of the aircrew in various categories explained on the following pages. How you can alter these names is shown on the next page.

Icons Available:

- Previous Section** Highlights the next section up.
- Next Section** Highlights the next section down.
- information** Opens a dialog box which indicates the orders for that section and allows you to change some of them.

Select for information.

This brings up the Aircraft Duty Screen shown on the previous page. On this screen you can alter the time of takeoff for the section, its basic mission, and the personnel involved. Use and to go between the Time field, the Duty field, the Aircrew field and the OK field. As you can see, you don't get to choose the aircraft you'll be using in your operation. As in real life, you have to make do with what has been assigned to you. If you come back to the same target later, you may find that you have been assigned different aircraft entirely. What you can do, however, is assign specific duties and crew to the aircraft you are given. The following aircraft duties are available:

- MIGCAP** Combat air patrol away from the target area.
- IRON HAND** Ground attack against AAA and SAM sites using normal air-to-ground weapons. On autopilot, its priority is for AAA sites. Will use Shrikes against radars.
- BOMB RUN** Strike mission against the primary target.
- WILD WEASEL** Ground attack against AAA and SAM sites using ECM pods for protection and the Shrike anti-radiation missile. On autopilot, its priority is for SAM sites.
- ESCORT** Ground and air cover with equal priority for AAA, SAM and GCI sites. Escorts engage MiGs if they are present.
- TARCAF** Combat air patrol at the target area.

For this particular operation, we will need to have a bomb run on the plant with a smart weapon. We have already selected a Paveway (see page 66) for the weapon. We also have to deal with a SAM site, so it would be best to have ^{our} second section of A-6s equipped for Wild Weasel activity and the Phantoms equipped for Iron Hand.

For aircrew, we need to find crews with good accuracy for the main bomb run and good Iron Hand skills for the Iron Hand and Wild Weasel missions. The Phantom crew should also have good dogfighting skill, but that is secondary to the Iron Hand skill for this mission. If you want to change the aircrew, use and to bring up new crew names.

Let's find out what the capabilities of our crews are.

- Select for Crews to get a list of the crews with their capabilities. The meaning of these capabilities are on the following pages.

AIRCRAFT INFORMATION

Next, we'll need to obtain information about the aircraft you'll be using in the mission.

From the CAG Screen, press [A] to get the Aircraft Information Screen.

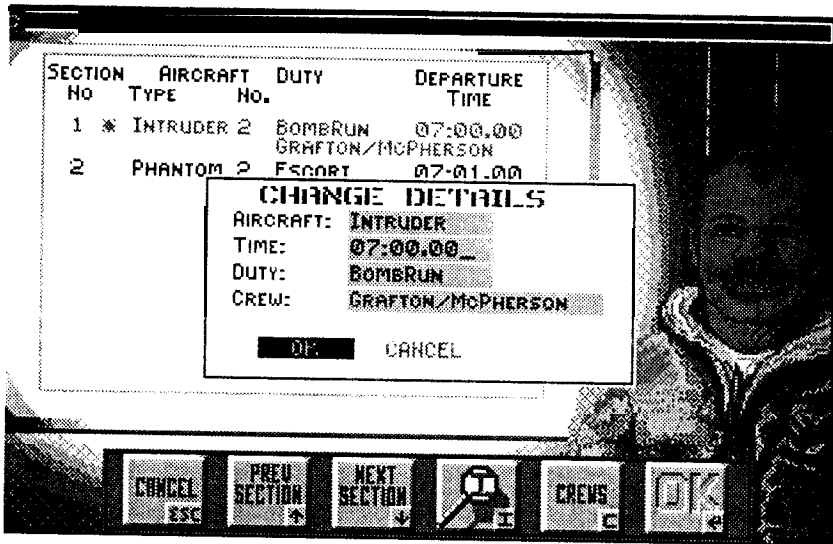

This is where you get the information about the aircraft in the chosen operation. The aircraft fly in sections of one or two aircraft for mutual protection. Most sections start with two members, leader and wingman. The exception to this is the lone Intruder mission that goes in low and fast in bad weather. Sections never consist of a mix of aircraft.

Each section is given a number. This is important as it is used to move between the sections when in flight; you press [Shift][1] for Section 1 and so on. This simulation has a limit of four sections per mission.

As well as displaying section number, aircraft type and number of aircraft in the section, this screen also shows duty, departure time and the aircrew of the lead aircraft. The duty dictates the type of job given to the section. This is explained later. If you want to alter the time of departure, this is the place to do it by moving the cursor with [↑] or [↓] to the "Time" line and editing the entry.

The aircrew information line gives the names of the pilot and B/N (or RIO) for the lead aircraft in each section. Pressing [I] gives you the ratings of the aircrew in various categories explained on the following pages. How you can alter these names is shown on the next page.

Icons Available:

- [↑] **Previous Section** Highlights the next section up.
- [↓] **Next Section** Highlights the next section down.
- [I] **Information** Opens a dialog box which indicates the orders for that section and allows you to change some of them.

Select [I] for information.

This brings up the Aircraft Duty Screen shown on the previous page. On this screen you can alter the time of takeoff for the section, its basic mission, and the personnel involved. Use [↑] and [↓] to go between the Time field, the Duty field, the Aircrew field and the OK field. As you can see, you don't get to choose the aircraft you'll be using in your operation. As in real life, you have to make do with what has been assigned to you. If you come back to the same target later, you may find that you have been assigned different aircraft entirely. What you can do, however, is assign specific duties and crew to the aircraft you are given. The following aircraft duties are available:

- MIGCAP** Combat air patrol away from the target area.
- IRON HAND** Ground attack against AAA and SAM sites using normal air-to-ground weapons. On autopilot, its priority is for AAA sites. Will use Shrikes against radars.
- BOMB RUN** Strike mission against the primary target.
- WILD WEASEL** Ground attack against AAA and SAM sites using ECM pods for protection and the Shrike anti-radiation missile. On autopilot, its priority is for SAM sites.
- ESCORT** Ground and air cover with equal priority for AAA, SAM and GCI sites. Escorts engage MiGs if they are present.
- TARCAP** Combat air patrol at the target area.

For this particular operation, we will need to have a bomb run on the plant with a smart weapon. We have already selected a Paveway (see page 66) for the weapon. We also have to deal with a SAM site, so it would be best to have our second section of A-6s equipped for Wild Weasel activity and the Phantoms equipped for Iron Hand.

For aircrew, we need to find crews with good accuracy for the main bomb run and good Iron Hand skills for the Iron Hand and Wild Weasel missions. The Phantom crew should also have good dogfighting skill, but that is secondary to the Iron Hand skill for this mission. If you want to change the aircrew, use [↑] and [↓] to bring up new crew names.

Let's find out what the capabilities of our crews are.

- Select [C] for Crews to get a list of the crews with their capabilities. The meaning of these capabilities are on the following pages.

You have one more thing to plan before actually executing the operation- assigning departure times to your aircraft.

Local time is entered in the following format: HH:MM.SS

Select the Time data field and type in 02 : 00.00. This will start the mission at 2:00 A.M.

Once YOU have set your aircraft and crew duties and departure times, it's time to Start the operation. Hit **[Enter]** to take command of your aircraft. In this game, just like the Navy, the CAG both plans and flies the missions.

Aircrew Personnel

In every mission, you can pick the wing leader air crew that will actually fly and fight the mission for you. The name and call sign you chose at the start of the mission Still gets the credit for the mission if you fly the plane; the team selected for the mission determines how well the planes in that wing operate when in *autopilot* mode. Each team starts with expertise in certain aspects of their mission; it is up to you to select the best team for the mission indicated, using the guidelines given below. *For simplicity's sake, the skills of the other aircrew in the section are automatically the same as those of whichever crew is selected.*

If you are in the cockpit when the mission is being flown, then Your success or failure affects the ratings of the air crew for future missions.

Assigning Plane Crews

- From the Briefing Screen, press **[A]** to go to the Aircraft Screen.
- Press **[C]** for Crews to get the list of available pilots. The lists are different for the A-6 and for the F-4. Look over the list to find a pilot team that has the best ratings for their mission. Remember that the ratings given are for the team at their best. If they have had several recent sorties and have a high Fatigue rating, their actual ratings may be far less than those in their personnel record.
- Once You have decided which crew you want, press **[Enter]** to get back to the Aircraft Screen and then **[I]** to go to the Information Screen. Select the Crew line with **[↑]** and **[↓]** and use **[←]** and **[→]** to move to the crew You want. Select that crew by pressing **[Enter]**.

Replacing Pilot Teams

If a plane is shot down and the pilot lost, the crews will be replaced by a simple entry of New Guys (A), New Guys (B), etc.

Personnel Descriptions

The following Pages contain abstracts of the fictional or real-life careers of the Pilots named in the crew lists.

Meanings of Ratings Categories

SORTIES-how many missions the aircrew has been on. The more sorties they have been on, the more likely they are to survive a mission but the worse their Fatigue rating.

FATI. (Fatigue)--current fatigue state. If the crew has flown Several missions recently, they are fatigued and less Competent.

ACC. (Accuracy)-how accurate the crew is at attacking any ground target with bombs, rockets and missiles when not fatigued.

W.W. (Wild Weasel)-how accurate the crew is at taking Out GCI sites with Shrikes or Standards when not fatigued.

D.F. (Dogfighting)-how good the crew is against aircraft when not fatigued. All the pilots have this rating, but Only Phantom pilots need it.

A-6 Pilot Personalities

Grafton/McPherson

Combat Sorties:	92	Bombing Accuracy:	Good
Fatigue Factor:	Good	Dogfighting:	Poor
Wild Weasel:	Poor		

Lieutenant Jake "Cool Hand" Grafton is a Naval Academy graduate, at the top of his class. Grafton chose to fly A-6s instead of F-4s, because he likes to fly "low in the mud where the action is." According to his skipper, he's steady and good. His BN, Lt. (j.g.) Morgan McPherson, is one of the best at being able to nail a target using radar. He's best-known for his ability to preplan missions, knowing the targets like the back of his hand. This team has been flying together for over two years.

Graustein/Wade

Combat Sorties:	5	Bombing Accuracy:	Bad
Fatigue Factor:	Fair	Dogfighting:	Bad
Wild Weasel:	Bad		

Both Graustein and Wade are "New Guys," fresh from the Naval ROTC (Reserve Officers Training Corps). They're unproven and their skill sets are unknown. Wade is the BN, enthusiastic but green.

Lundeen/Greve

Combat Sorties:	31	Bombing Accuracy:	Poor
Fatigue Factor:	Bad	Dogfighting:	Poor
Wild Weasel:	Fair		

Lt. Sammy Lundeen is not only Grafton's roommate but also the squadron's personnel and awards officer. Tall for a pilot, Lundeen has a wacky sense of humor. Lt. Marty Greve is his bombardier-navigator.

Parker/Rockwell

Combat Sorties:	38	Bombing Accuracy:	Fair
Fatigue Factor:	Poor	Dogfighting:	Poor
Wild Weasel:	Bad		

Lt. Commander Cowboy Parker has a lot of experience as the squadron's operations officer. He's popular with junior officers who respect his professional abilities and ability to take a joke. In addition, he's a good desk jockey and not a bad bomber who just needs some more time in the air to gain experience. Rockwell is his solid BN with a reputation for bombing gophers 50 feet off the deck at 500 knots.

Ford/Walkwitz

Combat Sorties:	76	Bombing Accuracy:	Poor
Fatigue Factor:	Good	Dogfighting:	Bad
Wild Weasel:	Fair		

Lt. Nathan Ford is a tireless pilot. He attended the Naval Academy and he is on his second tour of duty. His BN, Lt. Bob "Boxman" Walkwitz, is the master of flip comment. He's best known for liking wine and women equally well. He even likes going against SAMs--because he thinks it's fun.

Campbell/Cole

Combat Sorties:	131	Bombing Accuracy:	Good
Fatigue Factor:	Fair	Dogfighting:	Poor
Wild Weasel:	Bad		

Capt. Richard Campbell has flown many missions and is a tested pilot. His BN, Lt. Virgil "Tiger" Cole, counts among his medals the Distinguished Flying Cross after eight years in the Navy. After two combat cruises Cole became an instructor bombardier at VA-42. An Arizona native, Cole seems close-mouthed to all but his best friends. But when it comes to bombing, he's the best of the best.

Alien/Bartlett

Combat Sorties:	7	Bombing Accuracy:	Fair
Fatigue Factor:	Poor	Dogfighting:	Bad
Wild Weasel:	Poor		

Lt. Richard Allen and his BN Bobby "Pear" Bartlett are another set of "New Guys." Bartlett, an Academy graduate, is a good BN and has a steady stick. Allen, though, is unproven yet.

Augie/Durfee

Combat Sorties:	12	Bombing Accuracy:	Poor
Fatigue Factor:	Fair	Dogfighting:	Bad
Wild Weasel:	Fair		

Both Little Augie Odegard and Razor Durfee are Naval ROTC graduates. Razor, who's balding but with a moustache, would rather be in law school than flying jets. He's nervous and not terribly well-liked, but he is capable at his job of BN.

F-4 Pilot Personalities**Flynn Jr./John**

Combat Sorties:	35	Bombing Accuracy:	Fair
Fatigue Factor:	Poor	Dogfighting:	Poor
Wild Weasel:	Good		

Lt. Cmdr. Johnathan "Errol" Flynn Jr. and Lt. (j.g.) Robin "Little" John have been specializing in Wild Weasel missions since the capability appeared. "Death to Radar" is John's battle cry. They are recent additions to the Shiloh's squadron; this is their second squadron in one tour as they first were New Guys in another carrier wing on a ship that just departed. Between their quickly-won expertise as "Weasels" and their short time on station before their previous ship was rotated home, the Admiral of Task Force 77 was happy to agree to their requested transfer to a ship that "was still fighting." Many of their new squadron mates are afraid that Flynn and John have not yet learned that war is a deadly business. They treat it as a game.

Hyde/White

Combat Sorties:	5	Bombing Accuracy:	Poor
Fatigue Factor:	Fair	Dogfighting:	Poor
Wild Weasel:	Bad		

Captain Rod "Hell Raiser" Hyde and Ens. Bob "Animal" White are new "nuggets" in the squadron. Hyde, a graduate of the Air Force Academy in 1967, is a U.S. Air Force F-4 driver on exchange duty. White is a recent graduate from the NROTC program. Considered to be an average team by fellow aviators, these two are best known for their shore leave charades. They are well-liked, fun, hardworking and dependable.

Tucker/Salibello

Combat Sorties:	131	Bombing Accuracy:	Good
Fatigue Factor:	Fair	Dogfighting:	Fair
Wild Weasel:	Fair		

Commander Gene Tucker and Lt. (j.g.) Cosmo Salibello are credited with downing one MiG in their F-4J. A graduate from the Naval Academy, Tucker is considered one of the most experienced F-4 drivers in the Navy. This is Tucker's second tour of duty. Smart, well-respected, good at everything, and extremely committed to the job at hand, Tucker is a good leader.

Cunningham/Driscoll

Combat Sorties:	52	Bombing Accuracy:	Fair
Fatigue Factor:	Good	Dogfighting:	Good
Wild Weasel:	Poor		

Lt. Randy "Duke" Cunningham and Willie Driscoll, both graduates from the Navy's Fighter Weapons School ("Top Gun"), are the Navy's only aces of the war. On May 10, 1972, they managed to shoot down three MiG-17s with heat-seekers (AIM-9 Sidewinders), including the North Vietnamese ace Colonel Toon.

Toon was credited with 13 American kills prior to May 10th. Cunningham is considered one of the best stick and rudder guys in the business. This pair is the premier MiGCAP team in the Navy.

Freeborn/Elliot

Combat Sorties:	82		
Fatigue Factor:	Bad	Bombing Accuracy:	Fair
Wild Weasel:	Poor	Dogfighting:	Fair

Lt. Freeborn and Elliot are credited with the second MiG-21 kill by the Navy. This feat was recorded on October 8, 1967 while flying with Davis and Elie who are credited with a MiG-21 kill during the same engagement. Freeborn is a good ACM guy with a keen pair of eyes; he flew the F-3H Demon prior to the F-4 and served as a Phantom instructor before his first tour.

Davis/Elie

Combat Sorties:	56		
Fatigue Factor:	Fair	Bombing Accuracy:	Poor
Wild Weasel:	Fair	Dogfighting:	Fair

LCDR Bob Davis and LCDR Gayle "Swede" Elie recorded the first Navy MiG-21 kill seconds before Freeborn and Elliot shot down the second one. Davis and Elie are an experienced pair with good dogfighting skills.

Beardsley/Joslin

Combat Sorties:	73		
Fatigue Factor:	Bad	Bombing Accuracy:	Good
Wild Weasel:	Fair	Dogfighting:	Fair

Lt. Bill "Burner" Beardsley and Lt. Mike Joslin are a solid air&ground crew. Both are very experienced and served their first tour aboard the USS *America* (CVA-66). Burner joined the Navy in 1965. Beardsley is a good stick and rudder man and has been accepted to the Blue Angels flying team. He has never been hit in combat.

Grant/Sullivan

Combat Sorties:	4		
Fatigue Factor:	Good	Bombing Accuracy:	Poor
Wild Weasel:	Bad	Dogfighting:	Bad

Lt. Grant and Lt. (j.g.) Sullivan are brand new replacements. As far as nuggets are concerned, these two are reasonable going air-toground. They are fresh and eager but they have a lot to learn, especially in ACM and anti-SAM missions.

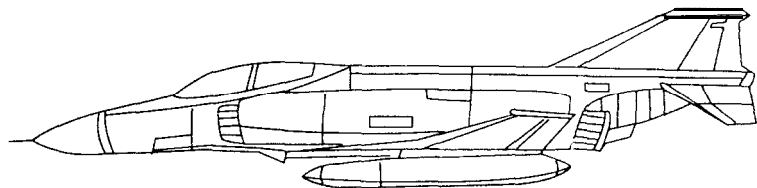

Enemy Encounters

United States aircraft had to run the gauntlet of both NV air and ground defenses. The major ground threat was AAA and SAMs. Generally the North Vietnamese used either AAA, SAMs or MiGs. The first wave of U.S. aircraft could tell the others whether it was a SAM or a MiG day. In this simulation we mix them together to represent the worst days.

Air Encounters

The enemy have MiG-17, MiG-19 and MiG-21 jet fighters. See the aircraft specifications in Part X. They are armed with cannon and Atoll heat-seeking missiles similar to the Sidewinder. This means that you are relatively safe as long as you haven't got a MiG on your six.

Ground Encounters

SAMs

For most of the war, the surface-to-air missiles used by North Vietnam were Soviet SA-2 Guidelines. Until late in the war, these only appeared in North Vietnam. Unfortunately, you are flying over North Vietnam.

The usual description of a SAM is that it looks like a flying telephone pole. They look deceptively clumsy. Many pilots learned how to avoid a SAM (see below) and then got complacent. But SAMs are extremely fast, hitting over three times the speed of sound and can be set off in three ways: by impact, proximity, and ground signal. United States leadership thought that the SAMs were probably the most significant threat in the skies of North Vietnam, and they proved a very potent threat.

Avoiding a SAM is easy if you know it is coming. Just make a hard turn when it is almost on top of you. Of course, if you do it too soon, it will turn with you. If you do it too late, it will just explode and down you anyway.

AAA

The Vietnamese employed many types of anti-aircraft guns, from the 37mm¹ cannon (an orange tracer) to the ubiquitous 57mm (which explodes with greyish brown smudges like pigtails) to the slow-firing but deadly 87mm (red puffs of smoke). At the start of the war, common wisdom was that anti-aircraft guns could never track a jet plane. Common wisdom forgot that^t AAA could put up a pattern of fire that could blow away a jet plane as easily^y as a Piper Cub. The best plan was to fly over 3,000 feet and jink a lot to throw off the radar tracking for the SAMs and AAA.

Rifles

Many planes were shot down by ground fire. Fly above 3,000 feet to avoid small arms fire. Of course, this makes you a target for SAMs and AAA.

Friendly Fire

Only 2% of U.S. planes were shot down by MiGs. 3% were lost to "own ordnance." Frequently this meant being hit by the shrapnel from your own bomb blast because you were flying too low.

PART VI: OPERATIONS AND MISSIONS

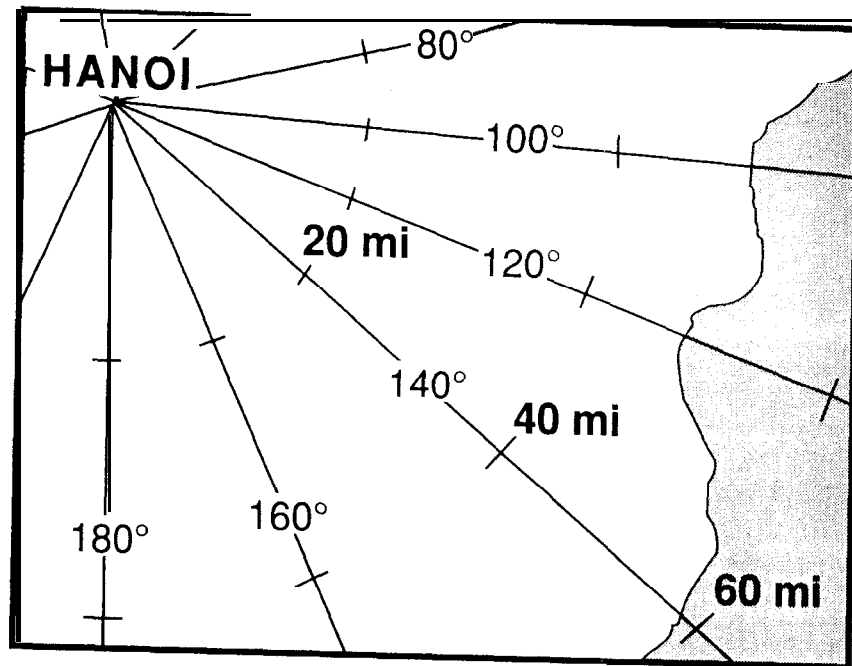

SELECTING AN OPERATION

The following operation and mission descriptions give you needed information to make a selection of what missions you would like to fly in Night of the Intruder. Two terms are used that should be explained before you go on.

Operation	The overall activities of usually several elements to accomplish an objective. Each element of an operation is called a mission.
Mission	The individual task of one element or section (usually two planes) of an operation. Missions have special titles such as Wild Weasel (suppression of SAM and AAA sites with anti-radiation missiles and ECM), MiG CAP (Combat Air Patrol against MiG incursions) and so forth. A full explanation of each mission title is given in the Glossary at the back of this manual.

RULES OF ENGAGEMENT

In certain of the missions you can find yourself having to deal with the same Rules of Engagement that bedeviled the U.S. military through most of the Vietnam war. These are rules made by your superior officers that limit what you can do in a combat. Breaking any of these rules can get a pilot court-martialed. During the Linebacker period, most of the Rules of Engagement were lifted, but in this simulation you can attempt to deal with the same problems real A-6 and F-4 pilots had to deal with in the unfriendly skies over North Vietnam.

These rules (as they apply to this simulation) are:

1. You may only engage MiGs that are airborne or in the process of taking off and which you or your wingman have visually identified as being bandits.
2. You may only attack mobile units: e.g. trucks, trains and off-shore enemy boats. This excludes any boats around the Haiphong harbor unless they have been designated as the mission's primary or alternate target.
3. You may only attack designated primary and alternate targets. You may not attack targets of opportunity. If operating as CAG, you cannot designate a target within ten miles of Hanoi or four miles of Haiphong.
4. You may attack any AAA, SAM or GCI site that is illuminating you with its radar (thus taking a hostile action) or has actually fired at you.
5. You may not activate your Master Arm Switch when within ten miles of Hanoi or four miles of Haiphong.

In the following Operation descriptions, the Special Instructions will indicate which are covered by the Rules of Engagement. This coverage can be cancelled through the **CONTROL menu** (see Part II: Menus). Also, if you are flying at Lieutenant j.g. or Lieutenant levels, Rules of Engagement are turned off by default. You will have to turn them on (if you want them) from the **CONTROL menu**.

COURT-MARTIAL

If a pilot violates the Rules of Engagement, he might be court-martialled. In this game, this means that that pilot is cashiered out of the Navy. The likelihood of being court-martialled increases with the level of difficulty as set on the

OPTIONS menu. If you fly at Captain level but all of your options are set to "Unlimited Arms" (that is, no check mark next to "Limited Arms") and similar values, then the computer realizes you are just playing a game and does not call you to account for your violations of the Rules of Engagement.

Besides violating the Rules of Engagement, you might be court-martialled (if you are flying at a high level of enemy activity) for:

1. Attacking your own ships.
2. Attacking your own planes.
3. Ejecting if you have sustained no damage.

If you are court-martialled, you can start a new pilot with the same name and callsign, but that pilot starts fresh with none of the points accrued by his former namesake.

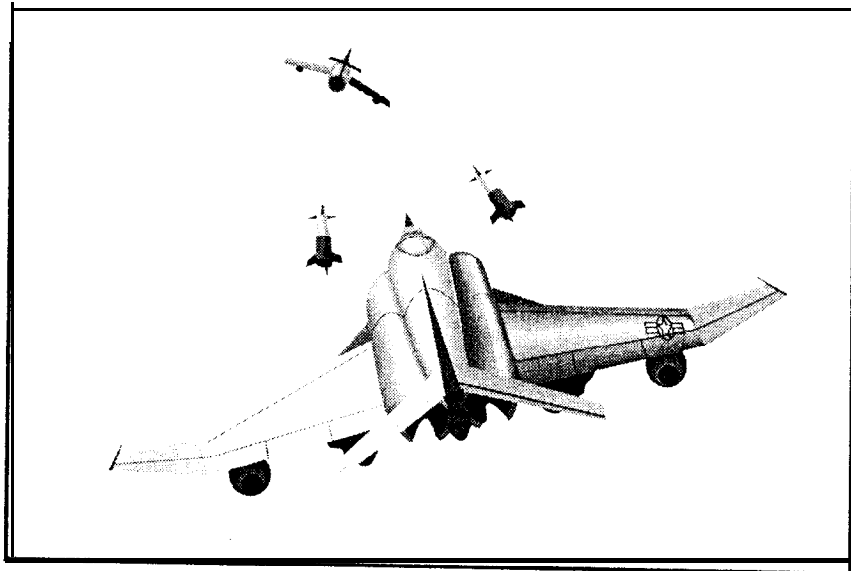

Operation BARCAP

Description: A dawn patrol around Yankee Station.

Objective: To intercept incoming threats from North Vietnam. Make sure there is no penetration of the 40 mile exclusion zone by plane or boat.

Special Instructions: Incoming aircraft could be friendlies or bandits so visual ID is necessary. Rules of Engagement apply.

Phantom Mission: MiG CAP

There is only one mission in this operation, and it is performed by a single flight of Phantoms. This combat air patrol mission should stay around top deck plus ten. Maintain a patrol area just off the North Vietnam coast.

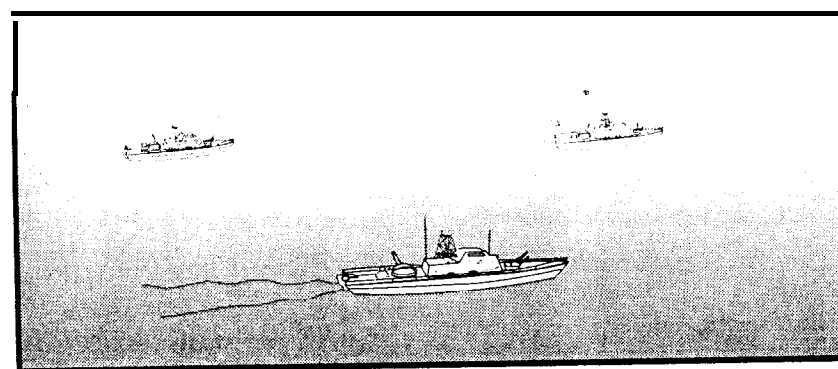

Operation DECK ALERT

Description: Scramble to meet a torpedo boat attack on the carrier.

Objective: To intercept three torpedo boats making a run on Yankee Station.

Special Instructions: Go in low to avoid enemy radar. Rules of Engagement apply.

Phantom Mission: Ducks in a Barrel

One flight of F-4s must intercept and destroy the torpedo boats before they get close enough to the Shiloh to launch torpedoes.

Operation TALLY HO YO

Description: Single strike bombing mission with fighter escort and Iron Hand.

Objective: Destroy the Yen Bai railroad bridge.

Special Instructions: The bridge is defended by AAA. Secondary targets (ware housing) exist in Yen Bai. Be prepared for targets of opportunity on the railway. Rules of Engagement apply to all other targets. There is supposed to be extensive MiG activity in the area.

Be sure to take plenty of fuel with you.

Phantom Mission: TARCAP

Precede the A-6s to the target area and eliminate any threatening MiGs

Phantom Mission: Escort

Escort the A-6s. On arrival, be prepared for targets of opportunity.

Intruder Mission: Iron Hand

A 57mm AAA battery has been reported to the north of the bridge. This needs to be silenced before the strike flight comes in. They are two minutes behind you.

Intruder Mission: Strike

Come in over the target two minutes after flak and MiG suppression by the other Intruders and the Phantoms. Use small smart weapons.

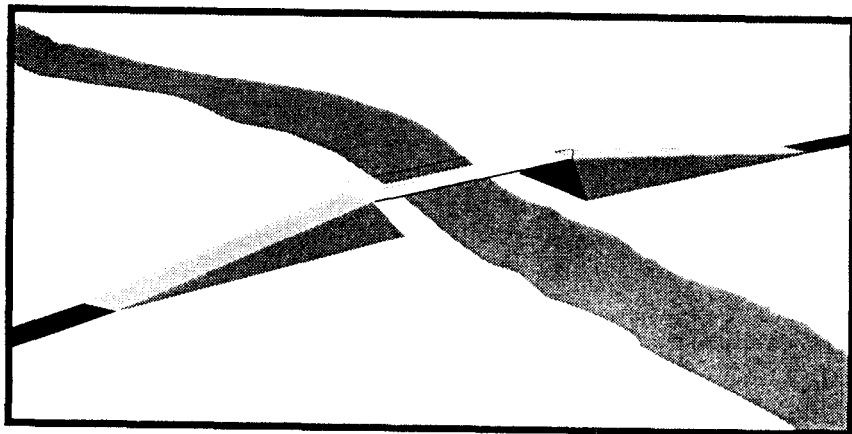

Operation BACK BREAKER

Description: Single strike bombing mission with fighter escort for MiGCAP and flak suppression.

Objective: Destroy the notorious Than Hoa bridge. Secondary targets include the AAA batteries radar guidance station and warehouses in the town.

Special Instructions: A low level direct approach up the estuary is suggested. This bridge has stood up against intense bombardment since 1965. Try to do it right this time. Rules of Engagement apply.

There is a high likelihood of traffic in the vicinity of the bridge.

Phantom Mission: MiGCAP

One flight of Phantoms required on combat air patrol to the north west of Thanh Hao. Cover required for the duration of the operation. Expect unfriendlies if the attack on the radar guidance unit is successful.

Phantom Mission: Escort

Accompany the A-6s to the target and eliminate any airborne opposition, then take ground targets of opportunity. Remember the Rules of Engagement.

Intruder Mission: Iron Hand

Heavy AAA placements on both sides of the river and bridge have been reported. The radar guidance unit to the southeast of the bridge is the main target.

Intruder Mission: Bullseye

Fly a low level route straight up the estuary. Fighter escort should keep AAA occupied.

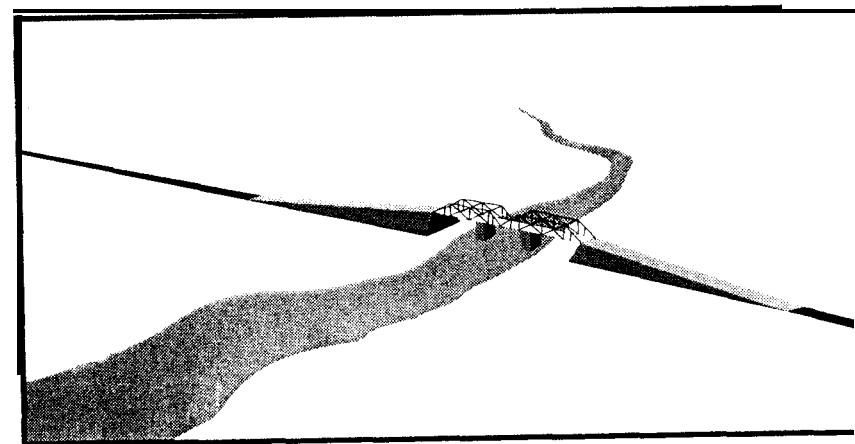

Operation MORNING SONG

Description: Single strike bomb mission without escort.

Objective: Destroy torpedo boats and missile cargo boats.

Special Instructions: This operation can be given to either a Phantom or Intruder section. Rules of Engagement apply.

You are without escort on this mission, so don't linger.

Intruder Mission: Green Tree

There is only one mission in this operation, and it is performed by a single flight of aircraft. Come in low over the sea from the east. Coast defenses will provide shipping with air cover.

Phantom Mission: Blue Tree

There is only one mission in this operation, and it is performed by a single aircraft. Come in low over the sea from the east. Coast defenses will provide shipping with air cover.

**Operation JULY 4TH EVE**

Description: Bombing mission.

Objective: Destroy the Phuc Nhac airfield in preparation for the July 4th celebrations (see below). Predicted bad weather should make a lone attack by a single A-6 feasible.

Special Instructions: No MiGCAP is provided. Ripple MK82s along the length of the runway. No second chances-you don't want MiGs chasing you.

Intruder Mission: Lone Ranger

No MiGCAP or SAM or flak suppression. The poor visibility makes conditions ideal for an attack by a single Intruder.

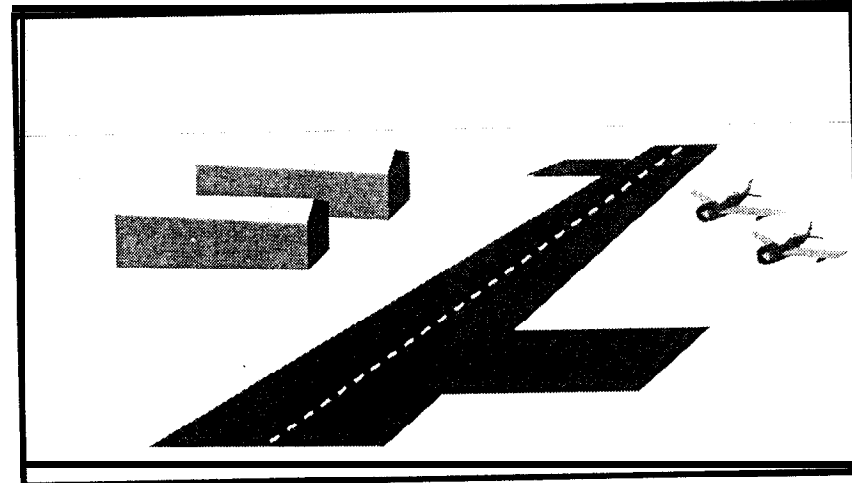

Operation JULY 4TH DAY

Description: Bombing mission.

Objective: Destroy the ammunition dumps reported in the town of Thanh Hoa. The main warehouse is reported to be empty. Most stores are in buildings around the hospital.

Special Instructions: Do not hit the hospital. It is recognizable by a red cross on its roof.

MiGCAP is provided to the northwest.

Phantom Mission: MiGCAP

Provide MiGCAP for the intruders coming in from the northeast. Take a look at the AAA batteries to the southwest of the town.

Phantom Mission: TARCAP

Provide CAP for the Intruders coming in from the southwest.

Intruder Mission: Fireworks

The safest approach seems to be from the southwest. This also puts the targets in transit. Phantoms will provide TARCAP.

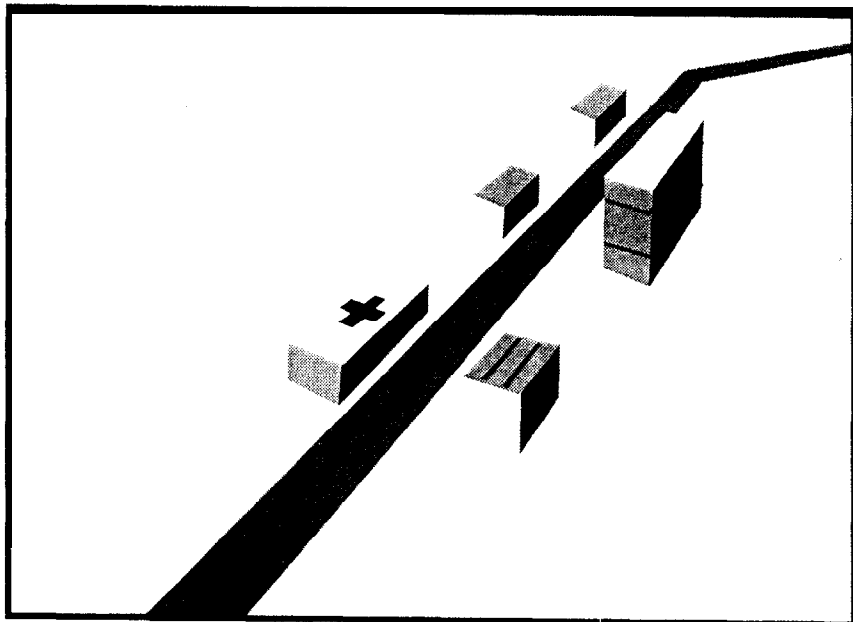
**Operation JULY 4TH REFRAG**

Description: Bombing mission.

Objective: Destroy the ammunition dumps reported in Thanh Hoa. The main warehouse is reported to be empty. Most stores are in buildings around the hospital.

Special Instructions: Do not hit the hospital. It is recognizable by a red cross on the roof.

Intruder Mission: Fireworks

No MiGCAP or SAM or flak suppression. The poor visibility makes conditions ideal for an attack by a single flight of Intruders.

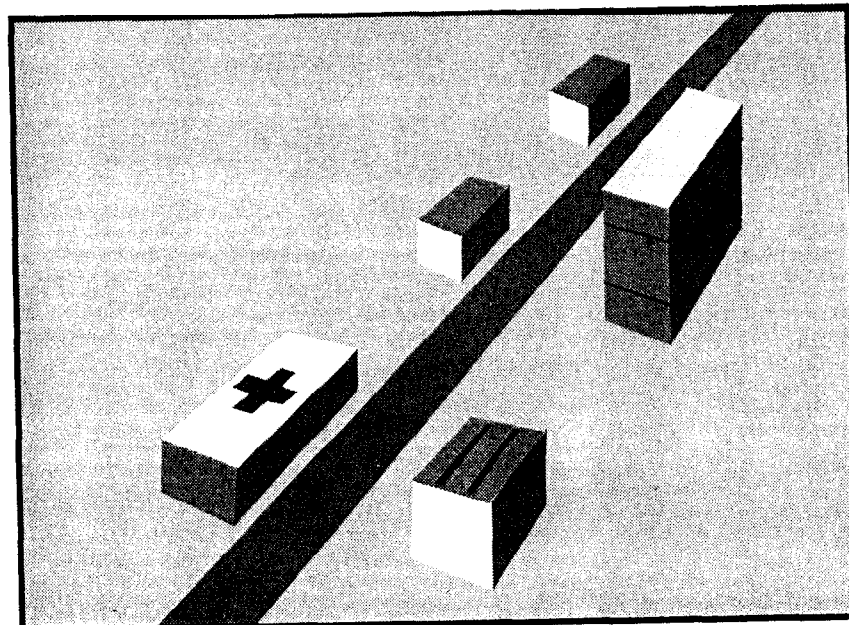

Operation LIGHTS OUT

Description: Double strike bomb mission with MiGCAP and Wild Weasel escort.

Objective: Destroy the thermal power plant at Hanoi.

Phantom Mission: MiGCAP

The main duty is to provide MiGCAP for the Intruders. They will be coming in two waves. Make sure you have enough fuel to stay around until everyone is on the way home. Expect company from the north.

Phantom Mission: Wild Weasel

SAM suppression is the main duty. However, the area is also defended by AAA.

Intruder Mission: Bomb Run One

Your objective is the main compressor house. It is the main building in the complex. The power station is in a residential area, so use guided weapons.

intruder Mission: Bomb Run Two

Go for the main compressor house if it is still standing. Otherwise go for the chimney or conveyor.

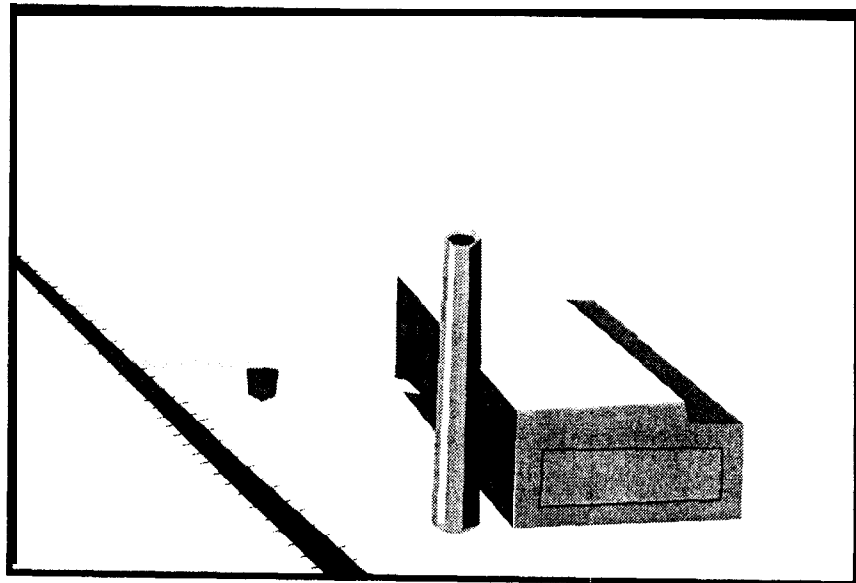
**Operation IRON RAIN I**

Description: A massive attack on Hanoi. This will take place in two operations: Iron Rain I and Iron Rain II. (See Operation Iron Rain II.)

Objective: Knock out Phuc Yen Airfield, suppress flak, and destroy SAM radar guidance equipment.

Phantom Mission: TARCAP

First in and last out. Engage any interceptors that are airborne.

Phantom Mission: Escort

Provide air cover for Intruders on low level attack on Phuc Yen airfield and downtown Hanoi. Seek targets of opportunity.

Intruder Mission: Wild Weasel

Seek and destroy the area's radar guidance units. Keep the enemy radar stations off the air.

Intruder Mission: Strike

The objective of this low level ripple bombing run is to close down the Phuc Yen airfield. The runway is the prime target; you may also attack grounded MiGs.

Clear up anything that the Alpha Strike missed

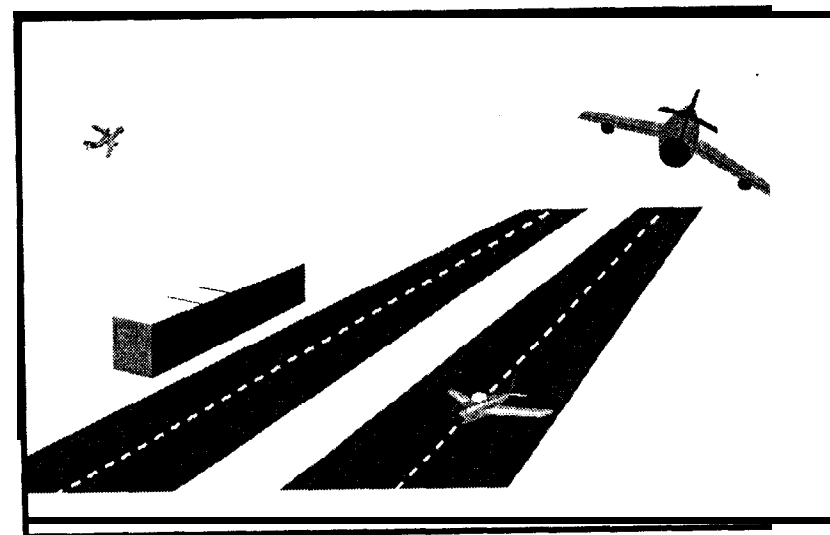

Operation IRON RAIN II

Description: A massive attack on Hanoi (continued). This will take place in two sections: Iron Rain I and Iron Rain II. (See Operation Iron Rain I.)

Objective: Bomb the Paul Doumer bridge.

Special Instructions: Iron Rain I should have weakened the defenses; however, MiGCAP and Wild Weasel escorts are provided for incursion into this heavily defended area.

Phantom Mission: MiGCAP

MiGCAP to the north of the target is required to intercept bandits.

Phantom Mission: Escort

Pick up your charges before going feet dry and provide CAP over the target.

Phantom Mission: Wild Weasel

There are over 84 SAM sites to keep you busy, mostly to the south of the city.

Intruder Mission: Knockout

This is an interdiction strike on the Paul Doumer bridge. A low level run from the northeast is advised. Direct hits on the spans are required.

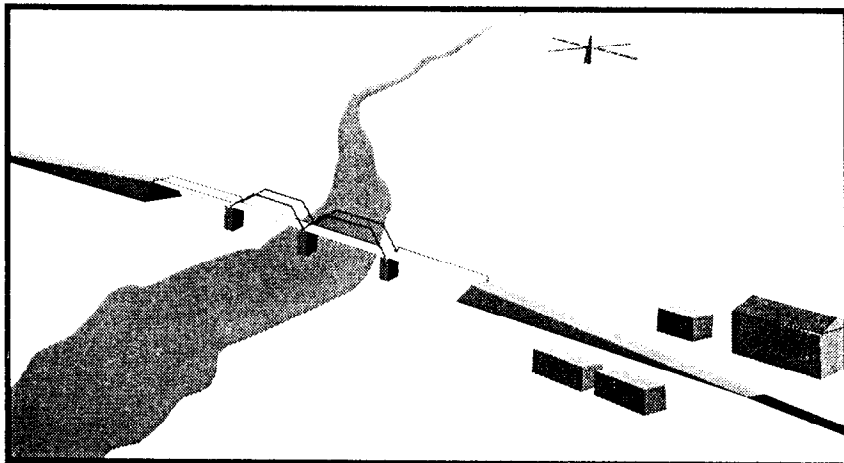

Operation ALPHA STRIKE

Description: A bombing run using all the available aircraft on a hitherto untouchable objective.

Objective: The objective of this Alpha Strike is to inflict damage on the Haiphong docks and shipping facilities.

Special Instructions: Do not attack the neutral shipping in the harbor, even if they shoot at you.

Phantom Mission: MiGCAP

Two sections of F-4s have been allocated to provide combat air patrol to the south of Haiphong. MiG-21s have been reported in the area.

Intruder Mission: Ballgame

The two big dockside warehouses are the main targets this morning. Also target any shipping in the bay.

Intruder Mission: Wild Weasel

SAM suppression is the main duty on this early morning mission. You will be protecting an A-6 flight which will target the dockside warehouses. Be prepared for targets of opportunity in the dock.

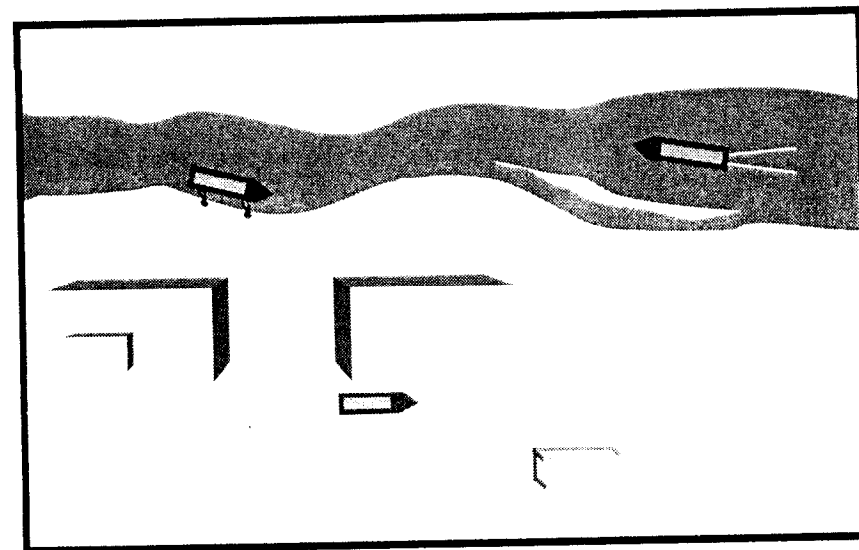

Operation HUNTER KILLER

Description: An ail-out attack on a pesky SAM site.

Objective: The six-launcher SAM site south of Hanoi is the target. Shrikes only hit the radar van, and the site is active again quickly. The bigger punch of Hunter Killer tactics are needed.

Special Instructions: Take out the GCI first to increase your chances. Don't make more than one run on the target, and use the biggest bomb load possible to do the most destruction. Rules of Engagement apply.

Phantom Mission: Escort

Two sections of F-4s are tasked to escort the A-6s. if possible, silence the light AAA to the south

Intruder Mission: Strike

The objective is to destroy the site. Target the launchers. The Wild Weasels will get the radar.

intruder Mission: Wild Weasel

Destroy the GCI and then keep the site busy so that the bombers can attack with impunity.

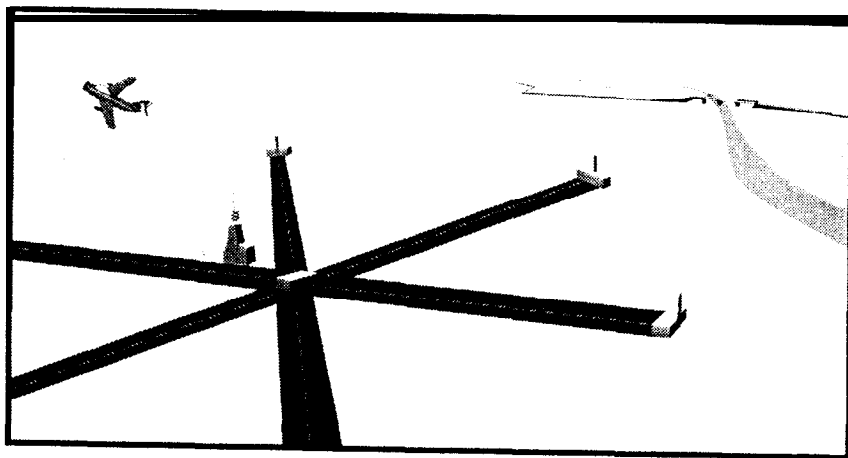

The Most Dangerous Game

by former U.S. Air Force Capt. Norman Cosand (1969-1976)

The Hunter *Killer mission* was, without a doubt, one of the toughest and most dangerous missions flown over North Vietnam in 1972. The Hunter Killer "team" (term used by Fighter Pilots) was comprised of two elements: 1. The Hunter element—two Wild Weasel F-105G's in the lead armed with AGM 78 missiles (an air-to-ground missile designed to home in and destroy SAM sire radar vans); 2. The Killer element—two F-4E's armed with CBU-52 (cluster fragmentation bombs designed to destroy metallic SAM missiles, transportation vehicles and radar vans) ready to



roll in on a moment's notice on the exposed SAM site. The aircrew members who flew the mission were all individually selected by the F-205 and F-4E Squadron Commanders because of the severe hazards associated with multiple SAM sires. Each SAM site was ringed with hostile 23mm and 37mm AAA gun sites. North Vietnam (in particular Hanoi) was considered to be one of the most heavily defended enemy countries ever known to aerial warfare. SAM sites, MiG bases and AAA gun sites carpeted the entire breadth of North Vietnam with an extra abundant concentration of defenses protecting the cities of Hanoi and Haiphong. Flying over the far reaches of North Vietnam was a daily "fireworks show" for the aircrews from Korat AFB in Thailand who flew the Hunter Killer missions. "First in and last out" was a standard operating procedure—time on target was longer, the defenses more intense and survival rate reduced. The Hunter Killer team was no picnic.

It was dark and humid at 4:18 A.M. when I arose from a restless sleep in my hootch at Korat AFB. I rapidly threw on my flight suit, put on my jungle boots and made my way to the Squadron Briefing room by 4:30 A.M. (via our reliable air crew van). Tension was written on the faces of the Captains and Lieutenants who were scheduled for today's Hunter Killer mission deep into North Vietnam. Our target was two SAM sites just southwest of Hanoi. With maps, classified photographs, weapon settings and enemy defense updates, I join the other team members for a comprehensive target briefing at 5:00 A.M. Briefing synopsis: "The weather is marginal en route (thunderstorms) but improving over Hanoi; the main target for the Strike Force (F-4s from bases in Thailand and South Vietnam) is the Thai Nguyen Steel Plant north of Hanoi; all MiG bases, SAM sites and AAA gun sites are active and operational; our Hunter Killer teams (call sign "Eagle") are to suppress two SAM sites prior to the Strike

Force's arrival and then remain in the target area to back up friendly forces, fuel permitting!" Breakfast at the Officer's Club was gulped down and barely digested. Takeoff occurs at 7:00 A.M. (exactly on time); we fill up with fuel from a KC 135 at 7:30 A.M. and drop off the tanker at 8:20 A.M. "Eagle flight topped off," radios the Hunter lead as we ingress to the target area with full fuel tanks and weapons checked for readiness. As we approach the target area I can hear the heavy breathing of the pilot in the front seat of my F-4E as we receive "Bandit" calls from MiG-19 and MiG-21 aircraft launching from several MiG bases surrounding Hanoi. I quickly discover that we are now 15 miles from two approaching MiG-19 aircraft. "Eagle Flight, Bandits attacking," radios the flight lead of another Hunter Killer team off to my left. Two Atoll missiles zip under my aircraft and disappear in the clouds behind me. We are still 100 miles from our target; the pulse rate picks up; it is going to be one of those rare days when both MiGs and SAMs are in joint defense of North Vietnam.

As we approach Hanoi from the Southwest, the lead F-105 launches an AGM-78 and quickly eliminates a SAM radar van from a site just east of the city. Travelling at 480 nautical miles per hour, I scramble in the back seat with my North Vietnam maps and target photos directing my element of two F-4Es to the first targeted SAM site, while the F-105G element pulls off to our left to provide coverage. I concentrate on the detail of my map and compare the map to rivers, roads and canals below; again I cross-check my map for landmarks. The target photo on the first SAM site is finally matched to a section of road near a small canal below.

A sigh of relief-no time or fuel was wasted, we are here to do the job we came for. The first SAM site is identified, we are ready to roll in at 60" of dive and supersonic speeds. My throat is dry and sweat races down my face as we pull 7+ g's coming off the first target. Half of our CBU-52 bomb load was just deposited on the SAM site below with thousands of pieces of shrapnel flying in every direction ensuring destruction of multiple surface-to-air missiles and radar equipment. As the second F-4-E pulls off the target and tucks close to my right wing, I pull my North Vietnam maps from a large clamp fastened to my G-suit and begin to immediately identify new landmarks below in order to expedite our ingress to the second target SAM site. Clouds partially obscure the second SAM site as we visually acquire the target. The ground below is suddenly lit up like a Christmas tree as AAA gun barrel flashes send a thousand rounds of 23mm and 37mm directly at our flight. Large red and orange silver dollar-sized tracers are close to my canopy; I can hear the "snap, crackle and pop" of the tracers as we point our nose at the second SAM site. "Eagle 3, SAM at 6:00 (six o'clock), break now," radios the lead F-105. My vision is gone; however, my mind is clear, I have "blacked out" as we pull nearly 9 g's to avoid the SAM (travelling at 3 times the speed of sound) that was homing in on our tailpipe. With vision now restored and our nose pointed skyward, we turn back toward the target for a second round. That SAM was alone, there would have been no way out had we been hit, diving at the ground and travelling at supersonic speeds. "Snap, crackle and pop" as dozens of tracers surround my F-4-E while

again diving at the second SAM site. "Thump," I feel the aircraft shake and lighten up as our last half of CBU-52 bomb load is released on top of the target. The second F-4E in our element also drops his CBU-52 and rejoins on our wing. Two SAM sites destroyed, all aircraft and aircrew are safe!

We are critically low on fuel as we rejoin the F-105 element. Our heading is 220° (southwest heading) as we egress back to Thailand. A KC 135 tanker is waiting for us over the border of Thailand and vectors north over Northern Laos to meet us. We are thankful for the tanker aircrews who risk 57mm and 86mm over hostile territory to refuel our empty tanks.

It has been a memorable day for the aircrews of Eagle Night as well as other flights who flew the Hunter Killer mission deep into North Vietnam that day. We are all thankful to be alive. We are also thankful that soon we can see an end to the war with North Vietnam, have our prisoners of war returned and set our feet once again on fertile American soil.

Captain Norman Cosand flew for the U.S. Air Force between 1969 and 1976. He was the Guy In Back in an F-4E and a Bomber/Navigator on an F-111. He flew 82 missions over North Vietnam including 41 missions over Hanoi as part of a Hunter Killer Team. He received 4 Distinguished Flying Crosses, 11 Air Medals and 1 Vietnam Cross of Gallantry.

PART VII: DEBRIEFING

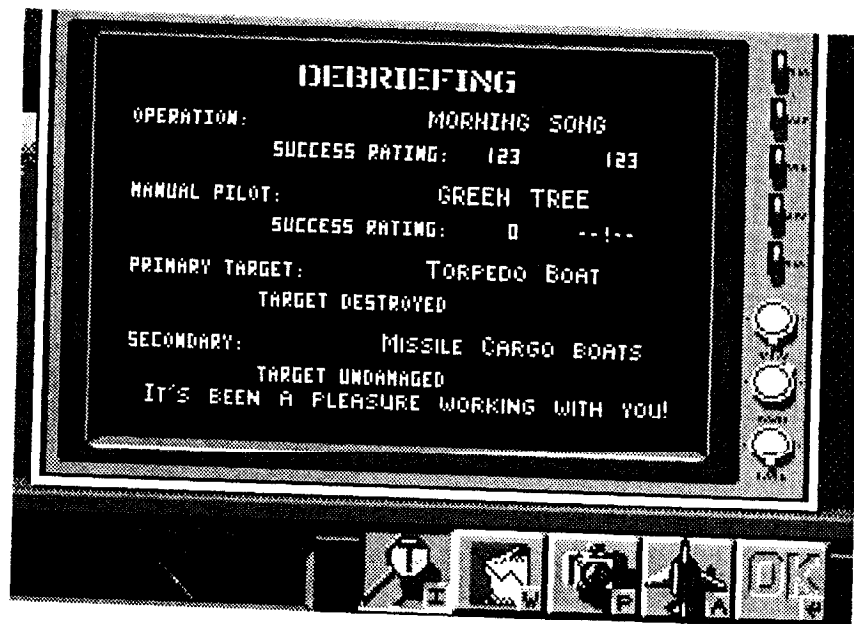

OPERATION STATISTICS

STATISTICS		AIR WING	MANUAL PILOT
OP SUCCESS RATING	Ave:	123	41
ORDNANCE USAGE	Ave:	500	50
AIRCRAFT LOST		0	0
MIG KILLS:	TOTAL:	11	10
GROUND TARGET KILLS:	TOTAL:	300	1
DUTY PILOT LANDINGS:			

Each time you complete a mission and successfully land your aircraft, You are taken to the Debriefing Room. where you can view your statistics for the current operation as well as the overall average for the entire tour. To start a new tour of duty, delete from the working floppy (not the master) all files with the extension .PLY.

The important statistic is the success rating (SR). You get a score for each mission you attempt. If your total exceeds 100, you earn the right to wear the Operation Badge. The scores for the various events are added together to Provide the Air Wing's Success Rating. Your personal SR is calculated by totalling the scores associated with those events which were directly attributable to you, and multiplying the score by the rank multiplier shown on page 25. For instance, you only get credit for destroying the primary if you were in control of the aircraft which dropped the bomb that destroyed the target.

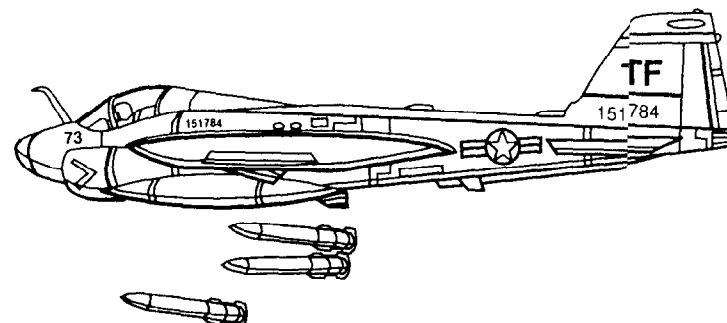

SUCCESS RATING TABLE

Primary target destroyed	100
Secondary target destroyed	50
SAM destroyed	25
MIG destroyed	25
AAA destroyed	10
PT boat destroyed	10
Guided missile on target	14
Unguided missile on target	12
Truck destroyed	5
Train destroyed	5
Player's landing	
green	10
black	0
red	-10
Carrier destroyed	-1000
Hospital destroyed	-1000
U.S. aircraft destroyed	-50
Guided missile released	-4
Unguided missile released	-2

Explanation of Icons

Information **I** This displays the Cumulative Scores Screen for the air wing and the individual pilot.

AVE (Average) on the screen refers to the air wing and pilot's average ratings (which are also reflected in the Sierra Hotel ratings described later). On the example screen shown here, the air wing has done better than its average for the mission described (125 instead of 82), but the pilot scored nothing (0 instead of 41).

Similarly, the air wing used less than its average amount of ordnance, while the pilot improved immensely on his ordnance usage, even though he hit nothing.

The totals, on the other hand, are always-increasing cumulative scores.

As the duty pilot, your most recent landing record is displayed in the form of a set of colored disks between brackets. The most recent landing is the disk furthest to the right under the "DUTY PILOT LANDINGS" entry:

Color	Result	Score
Green	OK	10
Black	No comment	0
Red	Dangerous	-10

STATISTICS		AIR WING	MANUAL PILOT
OF SUCCESS RATINGS	AVE:	125	0
ORDNANCE USAGE	AVE:	100	41
AIRCRAFT LOST	TOTAL:	0	0
MIG KILLS:	TOTAL:	11	100
GROUND TARGET KILLS:	TOTAL:	16	0
DUTY PILOT LANDINGS:			

Waypoint Review **W** Every few seconds the position of every aircraft is recorded. This information can show the aircraft track in review. It is possible to compare the ideal track following waypoints against the actual track. As the positions are being recorded relatively infrequently, it will not always be possible to completely review the track during a dogfight when direction changes are fast and furious.

Camera **P** This provides a record of your activities as if taken by a camera. Use the keys given to review your snapshots of the mission taken by using the "Take Photo" option in the **FILE** menu (see Part II: Menus) or pressing **PrtSc** while the game is playing. Select **P** to see the previous photo, **N** to see the next photo, and **D** to delete the photo currently on the screen.

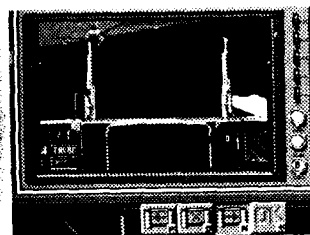

Use the arrow keys to pan around the picture. The knob in the bottom right corner of the monitor shows a letter corresponding to the photo. Review the photos taken in your previous mission by selecting "Slide Show" from the **FILE** menu.

Airplane **A** The "Video Replay" shows the videotape you took with the "Camera On" option on the **FILE** menu. Select **P** to play the current tape, **R** to go to the next tape, **S** to save the videotape to disk (the name you give the tape can only have six letters), and **L** to load a previously-saved video.

Aside from using the **FILE** menu option, you can also activate and deactivate the video recorder with **V**. You can record more than one sequence per flight, but there is a finite length. However, if you find yourself with a sequence you just have to save and your tape has run out, you can select **R** to reset the recorder. This wipes out **all** your previous records for that mission.

During the video playback, you can change to outside and tracking views, change the vertical and horizontal orientation, and fast forward by using **Tab**. You can get out of the playback at any time by pressing **Esc** and pause the playback by pressing **P**.

You can review the videos taken in your previous mission by selecting "Video Replay" from the **FILE** menu.

Saving to Disk

To save pictures and videos on a floppy disk, you must format a floppy disk, copy PHOTO- _SEQ from the game disk onto this disk, and rename the old PHOTO- _SEQ on the game disk (see the bottom of page 16 for renaming procedure).

BADGES

Every time you successfully complete an operation, a badge is sewn onto your flight suit. Occasionally you will see a picture of yourself and your crewmate in your flying suits. As you progress

through the simulation. You may see your suit become

gradually more colorful, when you earn the right to wear the badges. Also, the "trophy case" in the upper left portion of the screen will show all the ribbons associated with the medals you have won during the simulation.

You can also access the most recent version of this screen from the **FILE** menu before a mission by selecting "Awards."

There is another way in which you can be colorful. If the image on the award screen shows your flight suit dabbed with paint, it means that you have not landed on your carrier, the USS Shiloh, but instead on the other carrier sharing Yankee Station. Common practice on the carriers off Vietnam was to give the interloping aircraft a dabbing with whatever paint came handy, but in this game we paint the true offender, the pilot.

SIERRA HOTEL

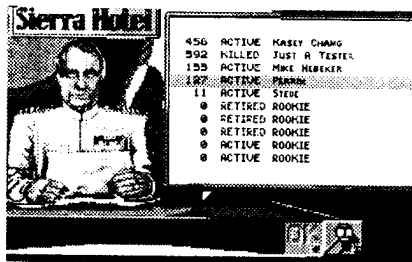

The Sierra Hotel screen lists the top ten pilots who have ever played from your disk—the "best of the best." The score given with each name is the average score for that pilot. A pilot with one good mission and several bad ones will disappear from the Sierra Hotel very quickly unless he has no competition. It is possible to do so poorly that all the "Rookies" (unused

slots on the Duty Roster) can have better scores than any pilot a player has played.

Press **I** to return to the Cumulative Score Screen described on page 96. Press **Enter** to return to the Duty Roster. From there, you can start another mission or exit the game.

The Sierra Hotel screen appears after every mission and you can access it from the **FILE** menu before a mission by selecting "Sierra Hotel."

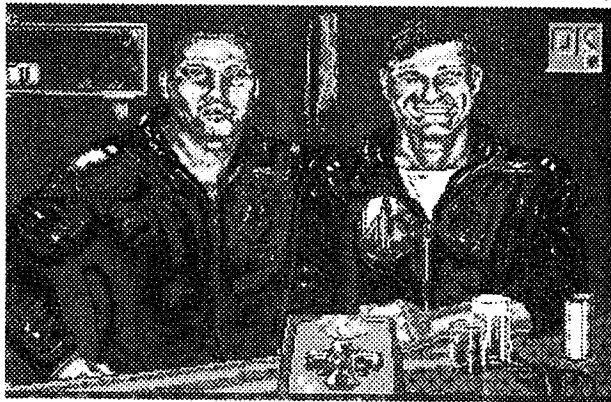

MEDALS

Medals had their beginnings in such knightly orders as the Knights of the Bath of England. A medal says that the person receiving it has done more than was called for. In Vietnam, some flyers began to feel that they were getting their medals just for waking up in the morning. Some pilots felt that they only got a medal if they fouled up a mission and took damage. If they did it right, no one noticed.

In this game we give you medals for doing it right, though the Purple Heart might be considered an award for blowing it big time. If you deserve an award, the Award Screen will appear (see previous page) and show a pilot displaying:

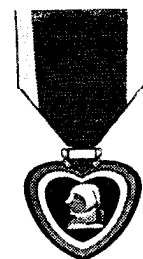
**Purple Heart**

Awarded when recipient has been injured in action

**Air Medal**

Awarded for every ten missions completed

**Distinguished Flying Cross**

Awarded for destroying two SAM sites, one MiG and three gun sites in one mission

**Navy Cross**

Awarded for downing one MiG which was attacking another aircraft

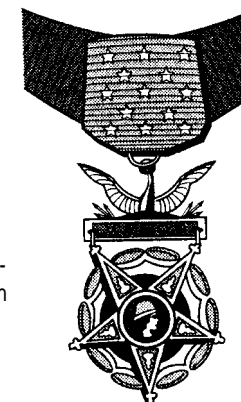
**Congressional Medal of Honor**

Awarded for personally destroying the primary and secondary targets of an operation

PART VIII: FLYING AND FIGHTING

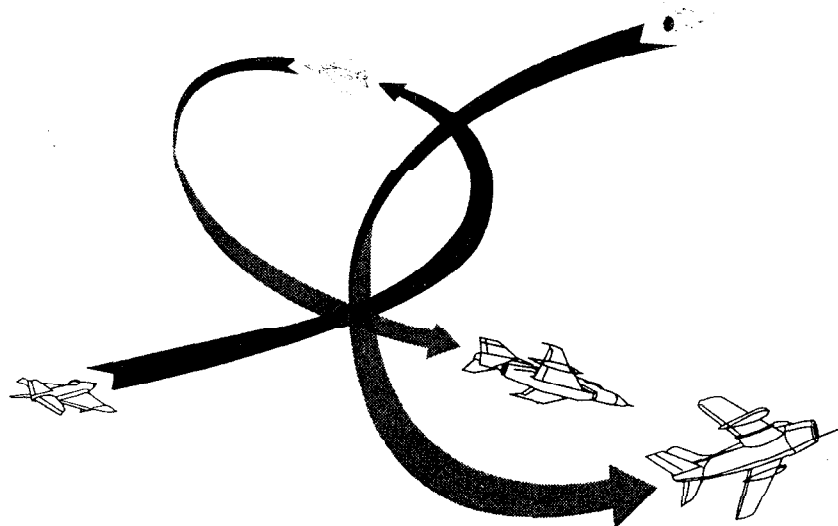

IN THE COCKPIT

The following is a description of the instruments found in the Intruder and the Phantom. As you might expect, the two aircraft have many instruments in common. In particular, you will find that the important flight instruments are arranged in the traditional "T" on both aircraft. This makes it easier to change from one aircraft type to the other. Nonetheless, you should be aware that there are important differences between the two aircraft types, and it's a good idea to take the time to familiarize yourself with them. The instruments are displayed with their names on the enclosed reference sheet.

In real life, both the Intruder and the Phantom rely on a crew of two. In the Intruder the crew sit side by side, while in the Phantom the RIO sits behind the pilot. In one of our few departures from reality, we have designed this simulation so that the aircraft can be flown by one person. We have attempted to do this while still maintaining as realistic a cockpit as possible.

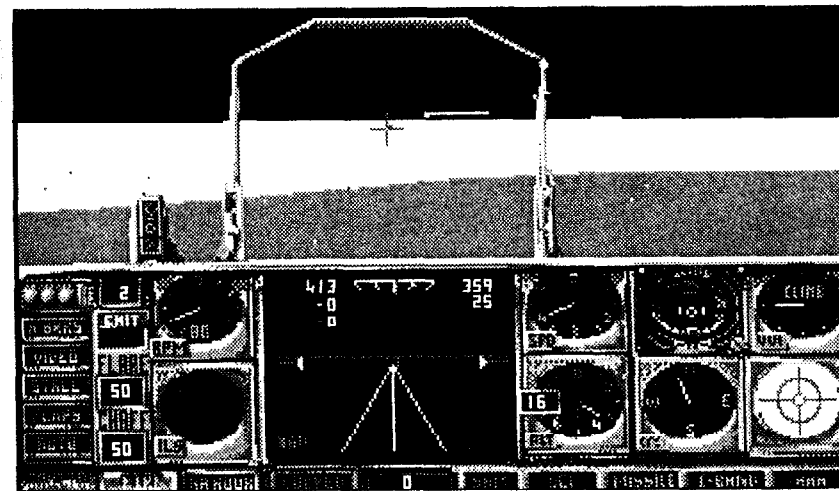

Intruder: As the pilot you sit on the left side of the cockpit. On your front view you can see the flight instrumentation. On your left 45° view, you look over the side of the aircraft. On your right 45° view, you look into the B/N's side of the cockpit at the stores and warning lights.

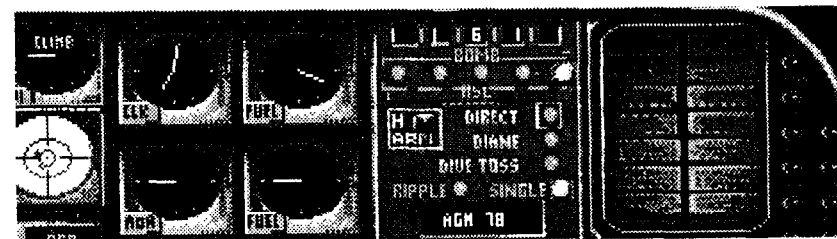

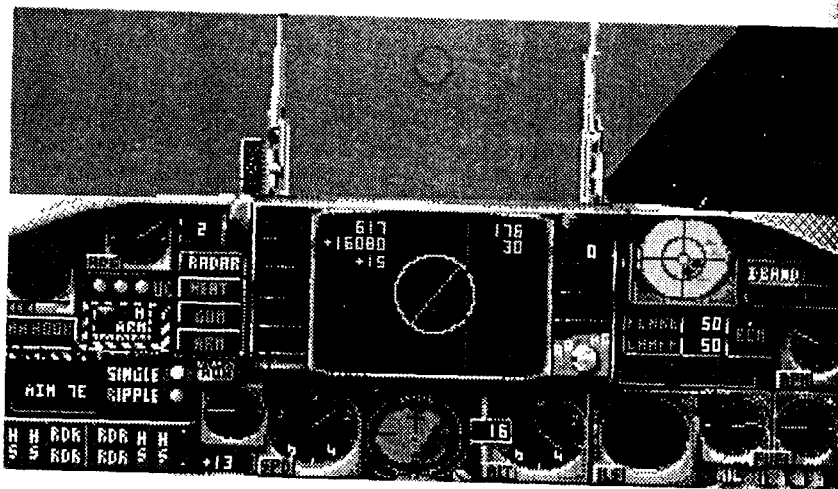

Phantom: The front view displays the flight instrumentation. Both the left and right 45° Views can be used to look over the side of the aircraft. Stores and warning lights are available on a lookdown front view (press **J**). This arrangement reflects the narrow but high front panel fitted onto the Phantom. The lookdown at the instruments view should be selected only for brief periods. You should have your head up and looking out of the cockpit 90% of the time. Your instruments are not trying to kill you, but lots of unfriendly objects outside the plane are.

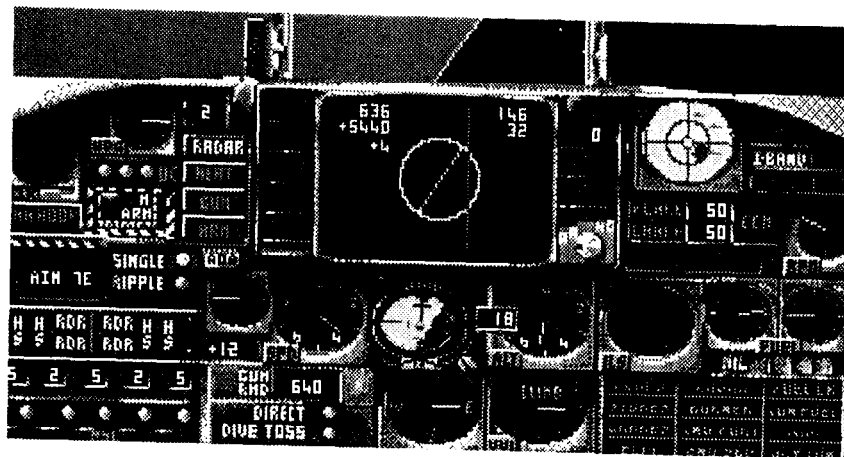

The HUD Dot

There is a green dot on the Head Up Display (HUD) on the front wind screen of both airplanes. This dot shows you your current stick position; it is provided as a convenience for mouse users and a reminder for joystick and keyboard users.

Instruments In Common

The following descriptions apply to both the Intruder and the Phantom:



Attitude Director Indicator (ADI): The ADI (sometimes called the "level ball") helps register your plane's position relative to the horizon as it rolls and pitches in any direction. The ADI is of vital importance in a dive because you use it to get your dive angle. Remember for manual dive bombing everything must be right: dive angle, speed and height. See pp. 128-129.



Compass: The compass shows your aircraft magnetic directional heading. For the purposes of this simulation, you can assume the compass has no problems with deviation and variation.



Altimeter: The altimeter's small needle rotates 360° for every 1,000 foot change in altitude. The large needle rotates 360° for every 100 foot change in altitude. The digits display the altitude in 1,000s of feet.



Airspeed indicator (ASI): The ASI consists of a dial calibrated in knots TAS (see Glossary). The zero position is at 12 o'clock. One revolution represents 1,200 KTS on the F-4 and 600 KTS on the A-6.



Vertical Velocity Indicator (VI): This dial measures climb and descent rate in 1,000s of feet per minute. The zero position is at 9 o'clock. Climb is represented by a clockwise movement of the needle. Three o'clock represents 6,000 ft/min.



Angle of Attack Indicator (AOA): This dial measures angle of attack in degrees. The zero position is at 9 o'clock, 30 degrees at 12 o'clock. Increased AOA is represented by an counterclockwise movement.



Fuel Gauges: When the tank is full (16,000 lb of fuel) the needle points to 6 o'clock. The needle moves counterclockwise to the zero position at 9 o'clock.



Tachometer: This dial measures the engine RPMs in percentages of the maximum: 0% at 12 o'clock and 100% at 10 o'clock. On the F-4 Phantom, the measurement cannot go below 70%.



Clock: This shows a standard analog display. The actual cockpit clocks show 24-hour "military time."

Threat Indicator and Panel

The threat indicator is also known as the Radar Warning Receiver (RWR). It tells you when you are being illuminated by someone else's radar and gives you an indication of who is illuminating you based on the wavelength of the radar hitting you. The indicators are:



Empty diamond	Friendly aircraft if radar is on
Filled diamond	MiG if radar is on
Filled red box	SAM in the air
Empty red box	Any active radar
Grey "hat"	Ship

The Threat Indicator Panel lets you know about enemy activity through warning lights.



Missile	SAM on the way
SAM	SAM site radar detected
AAA	AAA radar detected
I-Band	MiG radar detected
GCI	NV intercept Station detected



Angle of Attack (AOA) Indexer: The AOA Indexer is used primarily to assist in landing the plane. As the discussion in the next section shows, the plane needs to approach the runway at the right angle and speed when landing. If your speed is too high or low, the AOA Indexer remains unlit.

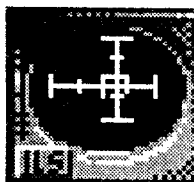

Automatic Carrier Landing System (ACLS) indicator: The ACCS Indicator assists you when making an instrument landing (called "following the needle"). The ACLS has two principal components: the Glide Slope Deviation (GSD) scale and the Localizer Deviation (LD) scale. See Part IX: Carrier Landings for details on how to use this gauge.

Press **F7** to activate the AOA Indexer and ACLS (see Part IX: Carrier Landings).



Sensitivity Indicator: This readout indicates the degree of sensitivity of your aircraft to turning, diving and climbing. Sensitivity varies from a low of 0 to a high of 3. At a setting of 1, the plane is less sensitive to directional changes and is easier to control. At a setting of 3, the turn, dive and climb characteristics of the simulation are virtually identical to those of the actual aircraft. (The most realistic setting is a sensitivity of 3 while flying at the rank of Captain.) The default sensitivity is 2.

Press **F3** and **F4** to increase and decrease the sensitivity.



Flare and Chaff Indicators: Flares are designed to confuse heat-seeking missiles by providing extraneous sources of heat for them to follow. The Flare Indicator shows how many flares you have remaining on the plane. Each plane starts off with 50 flares. You can turn "Limited Flares" off (see **OPTIONS** menu, page 23) for an easier game.

Chaff are packages of tiny foil strips designed to confuse radar-guided missiles. The Chaff Indicator shows how much chaff you have remaining on your plane. Each plane starts off with 50 packages of chaff. You can turn "Limited Chaff" off (see **OPTIONS** menu, page 23) for an easier game.

Reading the COMED

In EGA or VGA the colored dots on the COMED screen represent:

Red	SAM site
Blue/Cyan	Airfield
White	AAA site
Yellow	GCI
Grey	Targets and built-up areas
Pulsing square	You
Pulsing small square	Most recent enemy plane reported by Red Crown



Phantom System Lights

In most cases, the lights shown below indicate that the particular system is in operation.

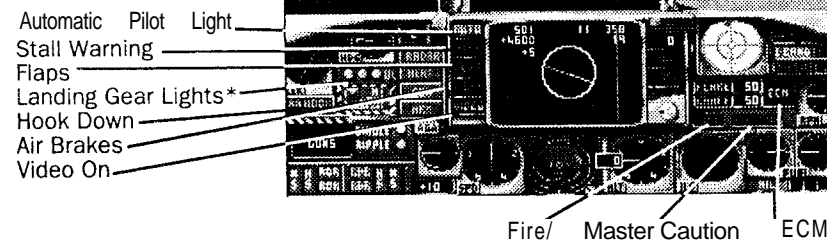

* The letters UC stand for Undercarriage, another term for landing gear.

The MILS Depression Reading tells both the A-6 and F-4 pilot the current Mil setting (see pages 128 and 130-131). It always displays zero until the Mil setting is changed. See the cockpit display on the enclosed Reference Card.

The EMIT light on the A-6 or the ECM light on the F-4 will illuminate if you turn on the ECM pod. If you have an ECM pod, toggle it on by pressing **E**. See the cockpit display on the enclosed Reference Card.

Intruder Warning Lights

A highlighted word in one of these panels indicates something is wrong.

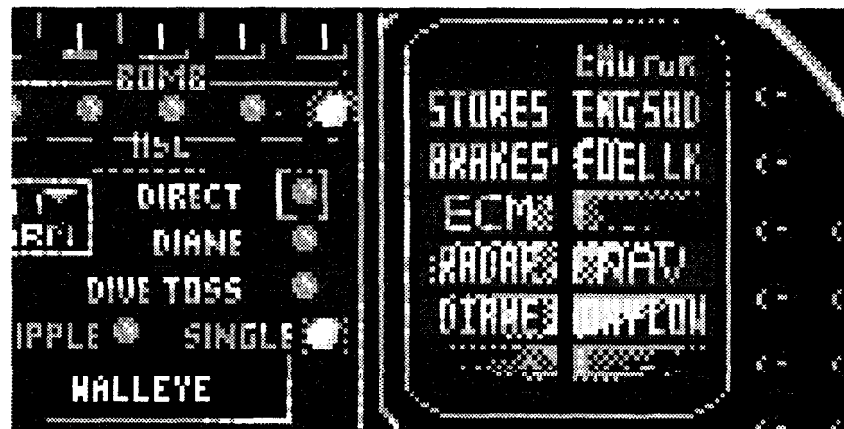

FLAPS

The wing flaps have been damaged and are frozen in their present state. For example, if they were up when the damage occurred, they stay up. Because flaps help curb excessive speed, the plane may be much harder to land. On the other hand, if the flaps were down when they were damaged, they stay down. This hampers the plane's maneuverability and prevents it from reaching top speed. To attain a needed speed takes more thrust and therefore uses more fuel.

STORES

Weapons cannot be released from external stores.

BRAKES

The Brakes light indicates a failure in the airbrake system. If the airbrakes were open when the damage occurred, they stay open. This is similar to Flaps damage (see above) and seriously threatens your plane's maneuverability, forcing it to fly at reduced airspeed. If the airbrakes were closed when the damage occurred, they stay closed, making the plane harder to land in some situations.

ECM

The threat indicator is out, and ECM (Electronic Countermeasures) is unavailable. You will have to rely on visual sightings and messages from friendly forces.

RADAR

The radar display is inoperable.

DIANE

The DIANE display is inoperable.

ENG PORT

Partial or complete loss of power in the port engine.

ENG SBD

Partial or complete loss of power in the starboard engine.

FUEL LK

A fuel leak. You will have to judge how serious this is. If you have not reached your target yet, you should probably turn back immediately.

Low Fuel

When this light comes on, you have a full scale emergency. You need first clearance onto a green deck.

Nav

The map display is not functioning.

oxy Low

indicates a drop in cabin pressure, usually caused by a bullet hole. Don't fly above 27,000 feet or you will black out, even when flying straight and level.

Intruder Multiple Weapon Selection Panel

The Intruder's Weapon Selection Panel is positioned on the right forward 45° view. Press **[7]** on the keyboard.

1. Weapons On Station: Set of five numbers. These indicate the number of weapons on each station.

2. Master Arm Light: Toggled with **[Home]**. Must be on before weapons can be released.

3. Description Panel: This displays the type of store at the selected station. Note that mixed store stations are not allowed.

4. Single/Ripple: Toggle using the **[9]** on the keypad. Single means that one weapon is released on each trigger press. Ripple means that all weapons on that station are released at one second intervals after pressing the trigger. Weapons on the wing stations are released in pairs to maintain a balanced aircraft. Ripple is not available for all weapon options.

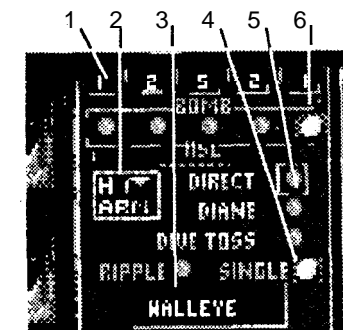

5. Direct/DIANE/Dive Toss: This option is toggled using the **[1]** on the keypad. It is not available on all weapon modes because it determines the bombing method.

6. Active Station: By pressing **[Backspace]**, the active station can be changed. The active station is indicated by activating the light below the weapons on the station number.

Phantom Warning Light Panel

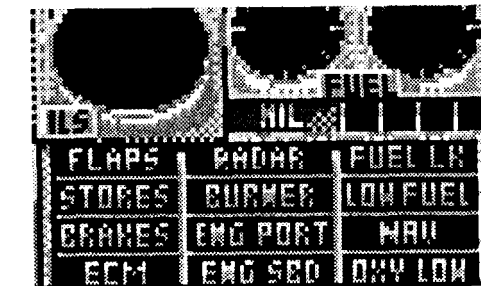

Refer to the Warning Light Panel diagram for the Intruder on the previous page. The Phantom F-4 panel is identical to that of the intruder except for the BURNER light in place of the DIANE light. The BURNER light comes on when you can no longer select the afterburner due to damage.

Displays Unique to the Phantom

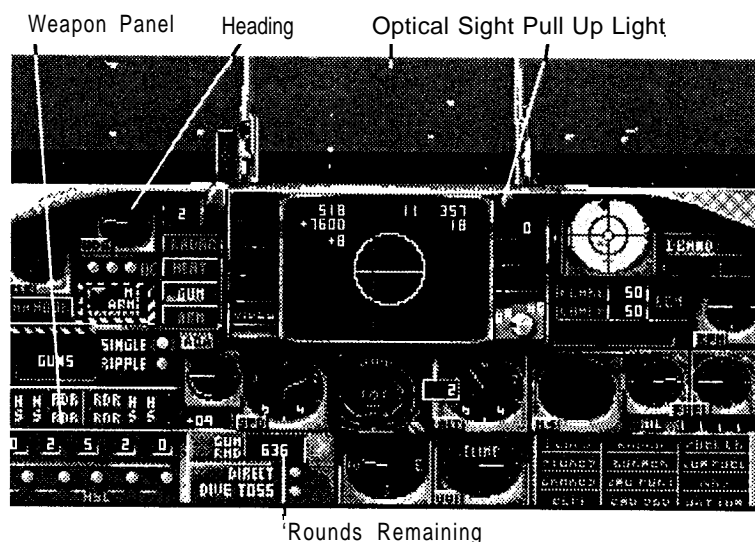

Multiple Weapon Control Panel: This shows you what weapons you are currently using.

Heading Indicator: This duplicates the compass so you don't have to go to the lower cockpit to find your current compass bearing.

Optical Sight: When shooting guns or rockets, fill this circle with the target and pull the trigger (press **Spacebar**).

Pull Up Light: This is a warning light that tells you when you are about to hit the ground.

Rounds Remaining: This shows how many rounds you have left to fire from your gun. To properly simulate the lack of a gun in the Navy's Phantom, players who have chosen the "Limited Arms" option have no ammunition for their gun. This is the default setting if you are flying at the Lt. Commander, Commander and Captain level.

The Phantom Radar Screen

The F-4 in this simulation has a radar screen that very closely emulates the radar used by Phantoms over Vietnam.

The sweep line updates the picture as it passes, the circle shows you what targets can be locked on, and the horizon line lets you know where you are in relation to the world.

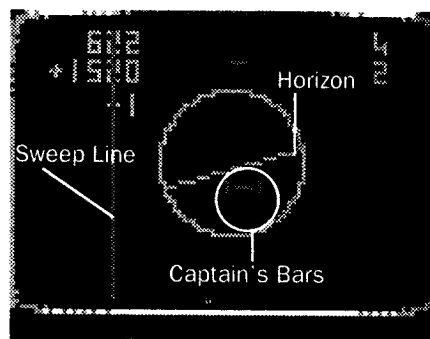

When the radar has locked onto a target, "captain's bars" show up around the radar image of the target, as shown in the image here.

Caution: If the radar is pointed at the ground, the screen fills up with static and it is virtually impossible for the radar to lock on a target. (This does not happen if you are using CGA graphics.)

Reading the Radar Screen

Many of the weapons available to you are radar-guided in some way. Others let you use your radar as an assist in locating the target. Unless indicated in a following weapon description, the radar screens on both aircraft will have a constant radar readout of five numbers—three on the upper left of the screen and two on the upper right. In all cases, these numbers mean:

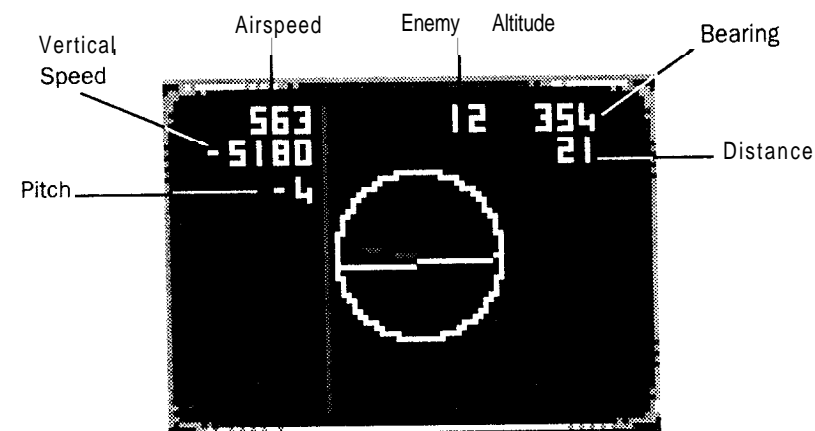

Pitch: The current pitch of the aircraft in aegees. Plus or Minus indicates whether the airplane is climbing or diving.

Vertical Speed: The vertical speed in feet per second. Plus or Minus indicates whether the airplane is climbing or diving.

Airspeed: The true airspeed in knots.

Enemy Altitude: This indicator only appears on the F-4 Phantom. When the radar is showing the distance to a flying target, a number appears here showing the altitude of the target in 1,000s of feet.

Bearing: The degrees you must turn to be either pointing toward your next waypoint or (for the F-4 Phantom) a possible flying target if the plane's weapons are in air-to-air mode.

Distance: The number of nautical miles to either your next waypoint or (for the F-4 Phantom) a target if the plane's weapons are in air-to-air mode.

If you have selected "Medium" or "Hard Targets" from the **OPTIONS** menu, you will not get any information on potential targets until you have a radar lock. Navigation information (relative bearing and distance to waypoint) will not show up if you have activated your air-to-air weaponry with **[Enter]**. Instead, the spaces will be filled with Xs. If you want to concentrate on your waypoints instead of your next air-to-air target, turn on your air-toground weaponry with **[Backspace]**.

Phantom G-Force Gauge

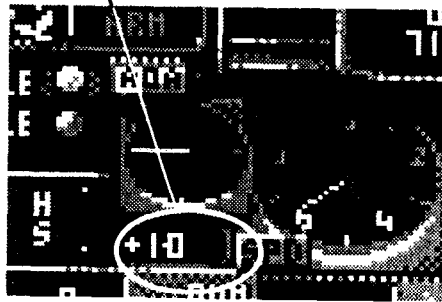

This readout on the F-4 tells you how many g's you are pulling (see page 111) at any time. Remember that the Phantom is not designed to take more than 7 g's for more than a few seconds. Too many g's for too many seconds and the plane falls apart.

Note that the displayed readout is giving us a reading of 1.0, not 10.

The Missing Instrument is the IFF (Identification Friend or Foe), a radio device that is used to determine which plane in the area is a friend. Friends transmit a certain signal; foes don't. This was turned off over Vietnam because it told the Vietnamese where you were.

OFFICER TRAINING

This is a section on how to fly your jets and, most important, maneuver them in air combat. But first, let's deal with some of the basics of jet flying.

THE NATURE OF G FORCES

The key to a jet being a good Air Combat Maneuvering (ACM) aircraft is in its ability to "pull g's" (also known as "turn g's"). G's represent the force of gravity that is being applied to the plane and its pilot and is commonly called "centrifugal force." G's dictate how fast and how tight a plane can turn at any given speed. All other things being equal, the plane that can turn the fastest usually wins the battle.

The effects of g forces on aircraft and pilots must be understood by anyone entering the air combat arena. Strictly speaking, a force of 1g is equal to the force exerted by gravity on a body "at rest." When a jet is flying straight and level, the lift generated by the plane's wings offsets its weight, to the point that both plane and pilot are experiencing a gravity force equal to 1g. This is equivalent to what you might feel while walking along a level street. Since increasing units of g forces are used to indicate the increasing force to which a body is subjected when accelerated, a higher "positive" number of g's represents a higher force of gravity. Decreasing positive numbers (even to the point of being negative) signify a decreasing force of gravity. Whenever you pull your nose into a turn or a climb (by pulling back on the stick or increasing your bank angle), you'll pull an increasing amount of positive g's. You've probably seen the centrifuge used in astronaut training that tests a person's ability to withstand centrifugal force. Whirling a person around in a circle at increasing speeds is very similar to what a pilot feels in a banking turn, and many of these turns are performed almost instantly. You begin to appreciate not only the pilot's ability to withstand the force, but the plane's ability as well. Pushing the stick forward results in pulling less or even negative g's, since you're not opposing the force of gravity anymore *per se*.

Positive g's push a pilot into the seat. At 7g's, your body experiences 7 times the normal gravitational force. This means that your 10 pound head weighs 70 pounds! At forces greater than 9g's, there is so much pressure that the blood stops flowing in your head, causing you to black out. A blackout results in a loss of vision or passing out completely.

On the other hand, negative g's force the blood into your head. Your body and plane can tolerate many more positive g's than negative g's. Excessive negative g's (greater than -3) cause your eyes' blood vessels to rupture. This is commonly referred to as a redout, which is just as dangerous as a blackout.

The typical fighter of the Vietnam era could only tolerate a maximum of 7g's. Even in 1985, an F-15 pilot pulled his plane into a high g climb with a full load of missiles and external tanks, which caused his plane to go out of control and disintegrate. You should take special note of this, especially if you're carrying any external stores.

How to Pull G's

Pulling and pushing on your stick controls turn radius and g forces. Banking your plane at steeper angles results in an increase in g forces and a decrease in turning radius. Pulling back on your stick will add additional g's. Pushing forward will subtract g's. Turns with excessive g's (more g's than are required to maintain an angle of bank) pull the plane into a higher angle of climb. Turns made with less than the required g's cause the plane to drop.

The flight Performance Envelope

The ability to pull g's is dependent upon a plane's flight performance envelope. Simply put, this is a measure of how many g's the plane can pull going at what speed and what altitude. In general, the faster a plane is going, the higher it has to be to pull a high-g turn. However, the plane also needs atmospheric density for its control surfaces to "bite" into, so after a certain height (different for each plane), you simply cannot turn it tight enough to pull high g's. Flying beyond the envelope (chasing too many demons too far) can result in a stall or total loss of control of your plane.

Pulling Out of a Stall

Learning how to pull yourself out of a stall can be a lifesaving matter. Flying beyond your plane's performance envelope can result in a stall. If you're flying too fast and trying to pull too many g's, all you have to do is relax off the stick.

Stalling because you've lost too much airspeed is a completely different matter. You can convert altitude into energy (airspeed) by going into a dive until you've built up enough airspeed and control before pulling out. Pulling out too soon or too hard can result in another stall.

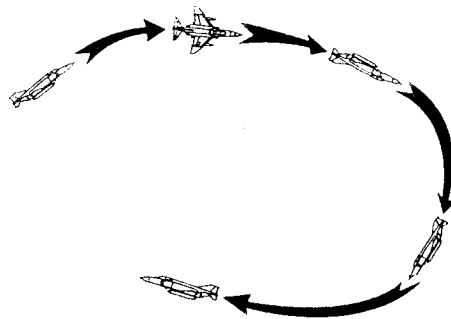

Keep Your Energy High

The usual mistakes made by a rookie are flying the aircraft too slow or too fast. Those flying their planes too slow are under the false assumption that slower speeds result in tighter turns and advantage during high-g ACM (Air Combat Maneuvers) environments. Pulling high g's bleeds off (reduces) airspeed. Flying too slow results in lower g capabilities. Pulling g's can force your airspeed to fall below the stall rate, resulting in an uncontrollable dive. Remember, speed is energy, and energy helps you get in and out of combat. Running out of airspeed (energy) is no fun in the heat of battle.

On the other hand, rookies have been known to carry this too far and attempt to dogfight travelling at Mach 2 (over 1,000 knots per hour). Trying to maneuver at Mach 2 is like trying to control a rocket that has gone ballistic.

As with everything else in the world, there is a happy medium. Most dogfights occur between 500 and 700 knots. This is the optimum speed for high g maneuvers as well as maintaining a high energy state.

When you maneuver sharply in the upper ranks of the program, expect to bleed off airspeed in the process. If you don't want this to happen, increase your RPMs to 100% or kick in the afterburner to minimize the effect as much as possible.

Avoiding Negative G's

You are capable of pulling up to 3 negative g's, though you'll start to redout if you exceed 2.5 g's. To pull negative g's, push your stick all the way forward.

Inexperienced pilots will initiate a dive by pulling negative g's. A better approach is to roll your plane upside down and pull positive g's toward the ground. Using this technique, you'll use gravity to go into a faster dive.

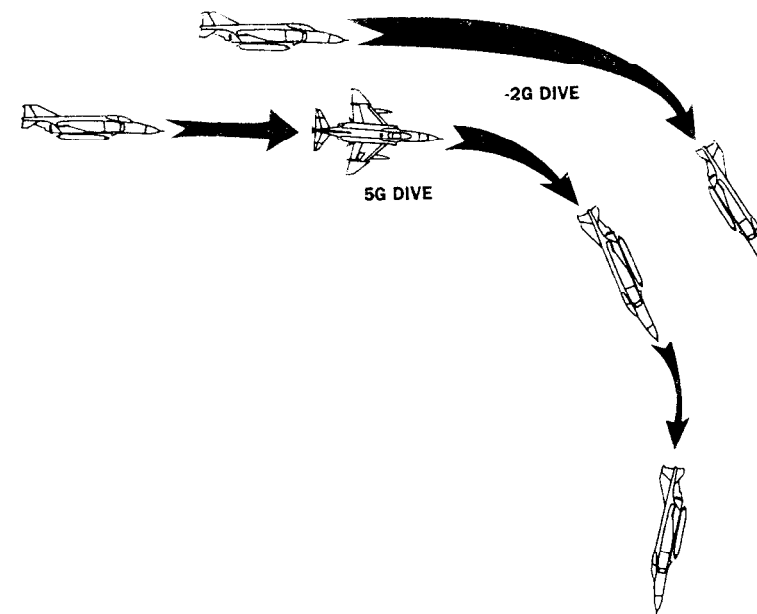

And So To Fight

And now that you know the basics of combat piloting, let's go on to some of the basics of plane-to-plane combat.

AIR COMBAT MANEUVERS (ACM)

Fighter pilots have to rove in the area allotted to them in any way they like, and when they spot an enemy they attack and shoot them down.. anything else is rubbish.

BARON VON RICHTHOFEN

To be successful in the fighter business the air crew must, first and foremost, have a thorough background in fighter tactics. They must acquire an excellent knowledge of all their equipment. Then they must approach the problem with a spirit of aggression and with utter confidence.

LT. R.S. LORD
ROYAL NAVY

We agree with the Red Baron that a good pilot is more important than any plane. Although if he had lived to see the agility of modern-day jet fighters, he might have changed his tune about the simplicity of air combat. Being aggressive isn't the only prerequisite to success in dogfight battle today. Rather, the pilot must be well trained in air combat maneuvers and apply an aggressive behavior to the fighting situation in light of his particular fighter's capabilities.

For example, a plane's ability to pull 7 to 9 g's in a matter of three seconds enables it to turn in an incredibly tight arc. However, as you have learned, that same capability will cause most pilots to blackout in the process. You must remember that the pilot and plane are working together, and following any series of maneuvers requires you to know exactly what your plane can do and work in harmony with it.

The maneuvers that we will be discussing are standard ones employed by fighter pilots throughout the world.

Engage

This is a basic offensive maneuver, where one plane will try to do anything in order to move in on the other's "six" for the kill.

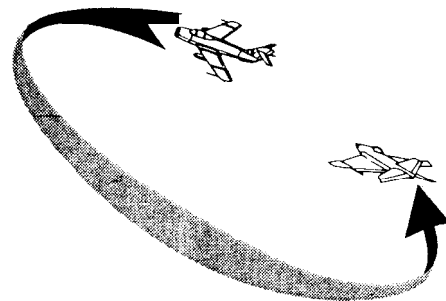

Break

A traditional defensive maneuver. When a plane is attacked from the rear, it turns hard into the pursuer's line of attack in an attempt to make the attacker overshoot. Use this maneuver whenever you get a warning that you have a bandit or SAM "on your six."

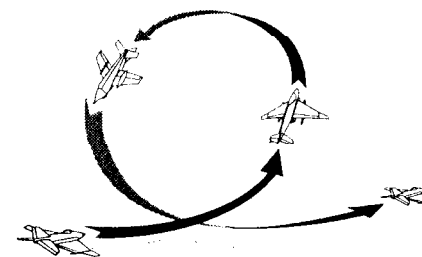
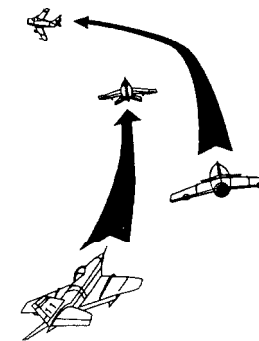

Vertical Loop

The Vertical Loop is used as an evasive maneuver. In its purest form, you pull into a sharp climb and simply come over the top and continue in the same direction. If

you complete this maneuver, you may be able to pull in behind the other plane. Otherwise, since the loop is relatively easy to perform, you can use it as a decoy while setting up another maneuver to execute immediately after coming out of the loop.

High G Yo-Yo

The High G Yo-Yo is an offensive maneuver that is a reaction to the "Break." Because the attacking plane is unable to hold position with the plane that is "breaking," it starts to pull less of a hard turn and moves vertically as well. During the climb, it rolls in the general direction of the predominant turn, so it can make an aggressive dive at the breaking plane from what is now a more favorable position. This maneuver is an example of using a vertical move to enable your plane to change position in less of a horizontal plane than a more conventional turn. If this maneuver is performed precisely, it can be very effective because the other "breaking" plane will find it hard to detect your position. Unfortunately, if you combine an ineffective turn with inadequate speed in the climb, the other plane will have plenty of time to move away.

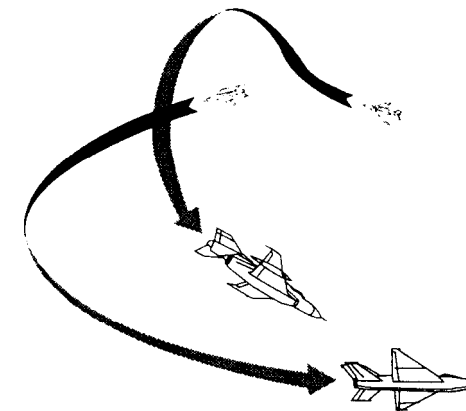

Low G Yo-Yo

This maneuver basically takes the opposite approach from the High Speed Yo-Yo to resolve a stalemate with a "breaking" plane. Rather than go vertical, the attacking plane goes into somewhat of a dive while maintaining as much of the turn as possible. The attacking plane then pulls up behind the other plane in a more favorable position. Don't dive too low or overturn, because the other plane will probably roll in behind you.

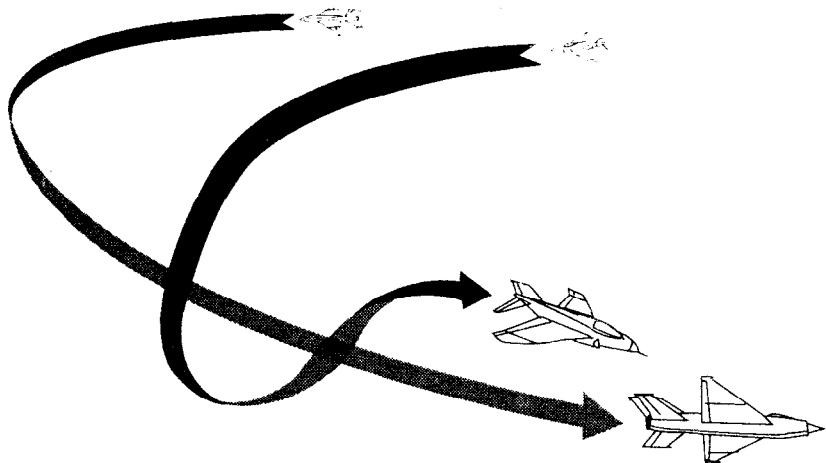

Flip Yo-Yo

This is a slight variation of the low G Yo-Yo. Rather than do a pure dive and risk pulling too many negative g's, roll your plane after initiating the dive. You'll also be able to pick up speed faster in this move than the more conventional Low G Yo-Yo. Take care to not overshoot the other plane due to excessive speed buildup.

Scissors

This maneuver results from a successful Break by the plane under attack. As the attacking plane overshoots its target, the other plane tries to turn the tables and move in behind the previous attacker. Both planes roll and criss-cross the other's path as each tries to gain the advantage. Your F-4 has an inherent disadvantage versus a MiG in this maneuver because the MiG has

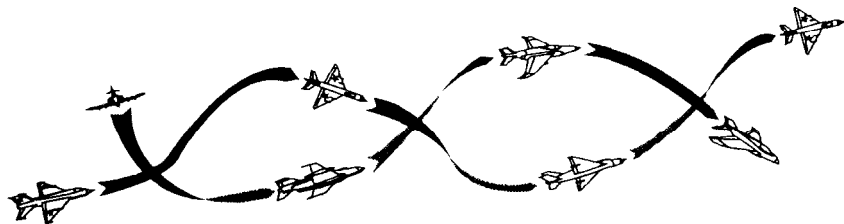

much better turning characteristics, but a skilled Phantom pilot can succeed with this maneuver versus Easy Targets (or versus Hard Targets if you are very skilled). The Scissors can remain in a stalemate for a relatively **long** period of time, until one plane takes the initiative and bails out or else initiates another maneuver.

Variable Scissors

This move is a variation of the Scissors maneuver. Rather than simply making rolling reversals in a relatively flat trajectory, both fighters also climb and dive while reversing in and out of each other's flight path. This maneuver is very unlikely to end up in a stalemate because of the numerous changes in position.

Split S

The Split S is a defensive maneuver that comes as a result of the attacking plane moving in too close. The target plane will roll upside down and pull into an accelerated dive before the attacking plane can react. The important thing is to do the half-roll before you dive, so you'll pull positive g's when you initiate the dive. You'll accelerate better and your body will withstand the stress better (remember negative g's?).

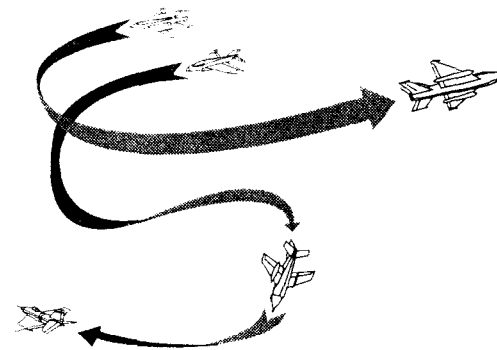

Head On

The classic confrontation, where unless either plane has been lucky enough to strike the other on the way in, the advantage is gained by the plane that can turn on the tighter arc to overtake the other. Because it's difficult to guess which way your adversary is going to turn after passing you, most pilots get used to looking over their shoulder to check on the opponent's next move, even while they're making their own.

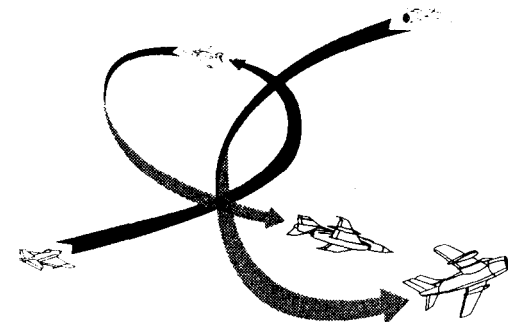

Rollaway

This maneuver is similar to the High G Yo-Yo discussed earlier. The main difference is that the attacking plane rolls in the opposite direction of the predominant turn before making its dive to regain the advantage.

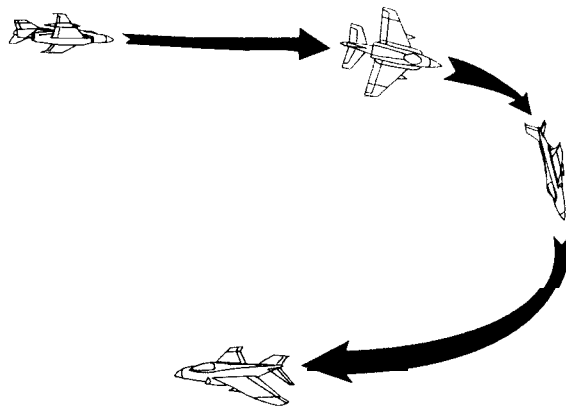
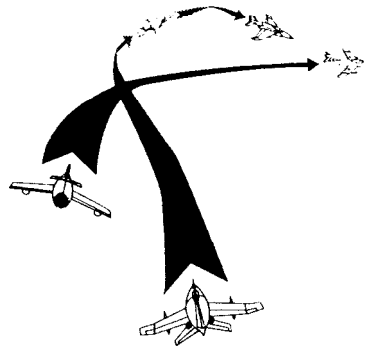

Dive Loop

The Dive Loop is a good maneuver to perform when you are being trailed by a pursuer that is still a relatively long distance away. As is the case in some of the other maneuvers, you have a more efficient turn because of the vertical emphasis.

Plus, it's more difficult for your pursuer to tell what you're doing, since there is no movement on the horizontal plane of sight. The key is to do a half-roll (invert) as you initiate the dive, so as to pull positive g's, initiate better acceleration, and achieve a tighter turn radius.

Lag Pursuit

When a plane under attack makes a Break, the tendency is for the attacker to overshoot. Sometimes though, the attacker is able to maintain its advantage by performing the Lag Pursuit, where the favorable position is held slightly behind and below the path of the target plane. Besides being able to match the target plane's turn rate, the attacking plane is able to prevent overshooting by occasionally pulling g's in a slight climb to bleed off speed.

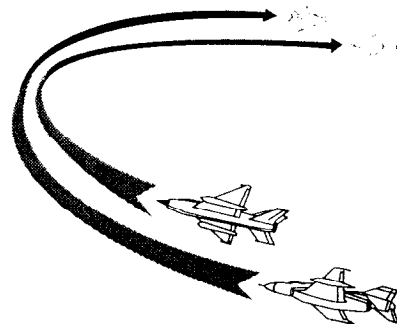

Immelmann

The Immelmann is a defensive maneuver where the plane being chased is trying to change direction in the least amount of horizontal area by rolling in a vertical climb, rather than using the more conventional turn on a flat plane. A hard vertical climb is followed by a roll into whatever direction you wish to go at the top of the climb. Your Phantom is not a good jet for performing this classic move dating from the First World War; avoid using it except in the most exceptional circumstances.

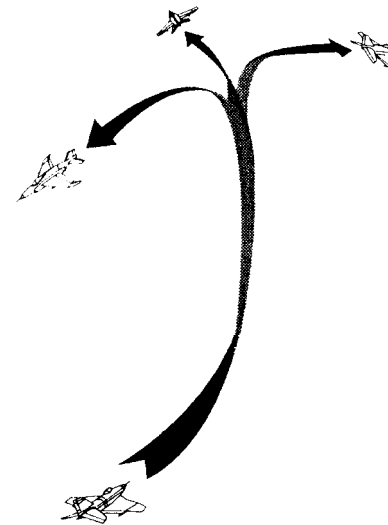

Suicide Prevention

There are a few things you can do if you are determined to commit suicide in the skies above North Vietnam.

1. Attack a target twice in one mission. Once you have been over a target, the gunners are ready for you.
2. Run away from a missile at full afterburner. Your exhausts make a wonderful target for a heat-seeking missile.
3. Approach a target slow and low. The AAA has lots of time to track you.
4. Try to out-turn a MiG. They turn much tighter than you do.
5. Try to outrun a SAM on the straightaway. They go much faster in a straight line than you do.



FUEL MANAGEMENT

Fuel management is an important element of this simulation. If you arrive at a target too early (by flying too fast and using too much fuel), you will have to leave the scene of the action earlier to get back safely. This might mean leaving others unprotected or the operation incomplete. On the other hand, if you have the MiGCAP role and arrive late, you may find that the aircraft you were supposed to protect has already been shot down.

During the conflict, the fleet that was assigned the job of attacking North Vietnam was stationed at Yankee Station. There was no precise location for Yankee Station. Generally speaking, however, it had to be far enough off the coast to minimize the chance of attack from land-based forces, yet close enough to allow the attack aircraft to reach their target and return. In this simulation we have moved Yankee Station so that it is close to the North Vietnam coastline. This is to minimize the flight time to target.

Fuel management was an important part of mission planning, and it would weaken the simulation if we ignored that fact. So to counter the fact that Yankee Station is closer than it should be, we have excluded the option of refuelling. At first sight this might be considered to be a disadvantage, but consider how tedious refuelling would be if it had to be done twice every mission. Nobody likes to stop to fill up with gas!

If the climb requires 2,000 lb and minimum fuel for your landing, or 'trap,' is 3,000 lb, there is enough fuel to cruise for about one hour. Say a round trip of 400 nm. Yankee Station is at 107° 30' East longitude and 19° 30' North latitude, so there is not enough internal fuel to get to Yen Bai. There is certainly enough for Thanh Hoa. There is barely enough for Hanoi.

You can start with "Unlimited Fuel" on the **OPTIONS** menu so that fuel consumption doesn't bother you while you are thinking of everything else. You can get a taste for fuel management by selecting "Half Fuel Use." The real test is to complete a mission at "Full Fuel Use" and bring the bird back in one piece.

Fuel Limits

The following information demonstrates that, with "Full Fuel Use" and "Normal Engines," you do have to watch your fuel consumption or, at the least, you won't get home. Mil stands for "military power" and refers to going at full speed without using afterburners.

Minutes of F-4 flight on afterburners	9
Minutes of F-4 flight at mil, no afterburners	35
Minutes of A-6 flight at mil	50
Minutes of F-4 full afterburner flight from carrier to Hanoi	16
Minutes of F-4 mil flight from carrier to Hanoi	21
Minutes of A-6 mil flight from carrier to Hanoi	26

USING THE RADIO

Multiple aircraft friendly missions make messages very important.

Messages appear as screen readouts on the top line of the screen and either a burst of sound or almost-legible speech (depending on your chosen sound option).

Messages are an important part of the game. The pilot receives messages from other aircraft and from his Bombardier/Navigator. You can tell where a message comes from by its color.

- Blue** Chatter from other aircraft and picket ships.
- White** A message directed to your aircraft.
- Green** A message from your Bombardier/Navigator (B/N) or RIO. In CGA mode this message is colored **Red**.

An urgent message goes to the top of the queue, but it does not clear the queue. You can review old messages by pressing **[PgDn]**.

Messages are not sent indiscriminately. For instance the sighting of a MiG is reported to MiGCAP leader. If MiGCAP leader is on auto, then the message triggers a response, e.g. engage or send out another section.

Messages have four main purposes:

- To signal the position of the enemy
- To request assistance
- To warn (e.g. SAM or Bandit sighted)
- To give information about progress of the operation

Callsigns

Each aircraft has a callsign. At the start of a mission, look at all the aircraft involved using the Outside View **[F5]** and you will see their callsigns.

Remember these callsigns or make notes, and you will have a good idea of who is calling and how much it applies to you.

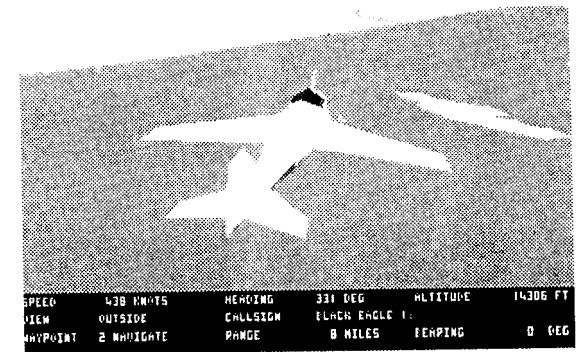

Clock Code

When sending messages, the "Clock Code" is used: straight ahead is 12 o'clock, straight behind is 6 o'clock (known as "On your six"). For example, "Bandit at your 3 o'clock, range 2 miles" means that there is a bandit on your right side at a range of 2 miles. Usually, the subject of the message is repeated twice, such as "Bandit, Bandit at your 3 o'clock, range 2 miles."

PHANTOM MULTIPLE WEAPON SELECTION PANEL

The panel is a variation of the A-6 panel and positioned on the lookdown front view (press). Differences account for air-to-air missiles and guns.

1. Displays similar to the A-6:

Include the Weapons On Station and Active Station Panel (WOSASP) which is situated at the bottom left of the front panel. The dive toss/direct lights are to the right, and above them the rounds remaining in the gun are displayed. Above the WOSASP we have the missiles available panel. Lights indicate the

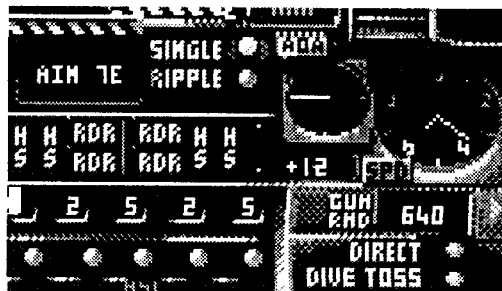

current load of air-to-air missiles. Above that we have the description panel and single/ripple lights side by side. The master arm light comes above the single/ripple lights.

There are two more instruments/switches

2. Active Weapon Light Panel: Indicates which weapon is currently active.

Readout	Active Weapon
Radar	Sparrow selected
Heat	Sidewinder selected
Gun	Gun selected
Arm	Air-to-ground weapon selected



3. AA/AG switch: Changes your weapon types between air-to-air and air-to-ground. Pressing changes the active AG station. If is pressed, then the AA/AG switch is turned and the first AA weapon is selected. Pressing further changes the active AA station. This station must be changed using the keyboard. The switch is on the screen for show.



AIR-TO-AIR WEAPONS

It is assumed that you have selected the weapon type you want to fire. See the Multiple Weapon Selection Panel above. Remember that the following only applies to the F-4 Phantom. The A-6 Intruder carries no air-to-air weapons.

AIM-7 Sparrow

Purpose The AIM-7 Sparrow is a radar-guided anti-aircraft missile for use at long range only. If you are expected to confirm your target before firing, you may be too close to use this weapon.

Maximum range at low (0-10,000 feet) altitude: 14 NM
Minimum range at low (0-10,000 feet) altitude: 2 NM

Head-on Stern

Maximum range at high (10,000+ feet) altitude: 7-8.6 NM 3 NM
Minimum range at high (10,000+ feet) altitude: 2 NM 1NM

Selection Press until AIM 7 comes up in the display box, the Radar light comes on, and the cone circle appears on the radar screen.

Aiming Steer to keep the blip on the radar screen within the circle. When you get the captain's bars to appear around the blip, then you have locked on. Press to release the missile. Continue to point at the bandit and the missile should lock and guide. The bandit must be illuminated by the 65" cone of the fighter's radar the entire time that the missile is flying. Generally fire in pairs to improve PK. During a Sparrow kill you will have your head inside the cockpit for much of the time.

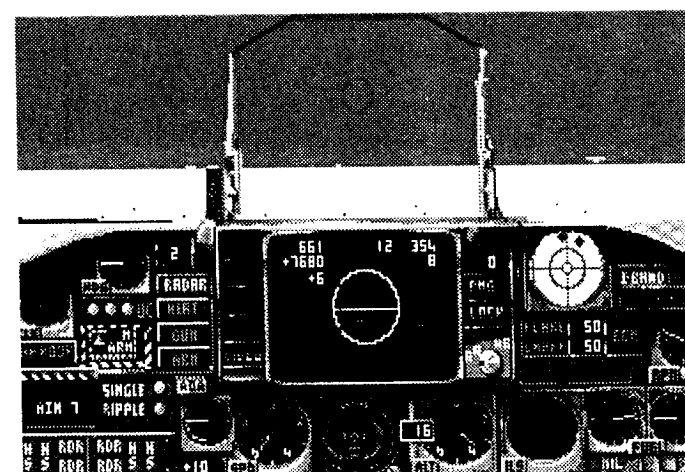

Notes

The Sparrow is 12 feet long, has an 8 inch diameter and a 3 feet 4 inch fin span. It takes 4 seconds to lock on to a target and 1.5 seconds to release. It can accelerate to more than 1,200 mph in 2.5 seconds. It takes 40 seconds to cross 40 NM.

The Sparrow had a disappointing 10% kill rate in Vietnam. It was virtually useless below 8,000 ft.

AIM-9 Sidewinder

Purpose Sidewinders are heat-seeking missiles used in air-to-air combat with a useful range of about two miles. Although hits have been recorded at seven mile range, this is not probable since a strong heat-source is required for tracking.

Selection Press **[Enter]** until AIM 9 comes up in the display box, the Heat light comes on, and the cone circle appears on the radar screen.

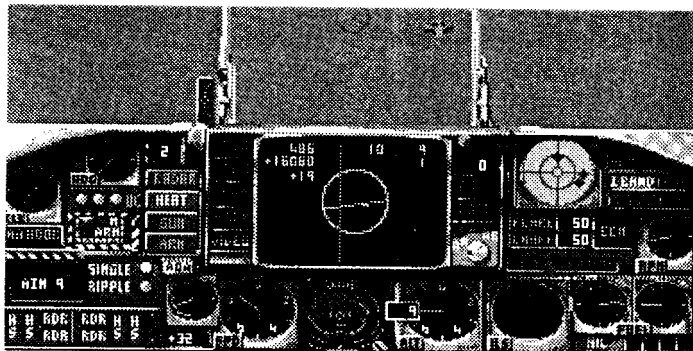

Aiming Follow the same general tactics as described for the Sparrow. However, you are fitted with an early version of the Sidewinder so you don't have all-aspect firing capability. Maneuver the aircraft to get on the bandit's tail. You should get a lock at a range of two miles. Press **[Spacebar]** to fire the missile. Generally fire in pairs to improve PK (probability of kill).

Because the missile is guided by an infrared homing device mounted behind the glass nose of the weapon, the missile is a fire-and-forget weapon. You do not need to stay lined up on the target after firing.

Notes Like the Sparrows, the Sidewinders had a disappointing kill ratio in Vietnam. Among their problems were an inclination to lock onto the sun if it was in their way and a penchant for losing targets against ground heat sources.

For this simulation, you can choose how effective your Sidewinders are with the **OPTIONS** menu.

- "Easy Targets" Sidewinder is an all-aspect weapon.
- "Medium Targets" Pilot must point at the bandit's rear quarter to get a lock on.
- "Hard Targets" Missile must continue to point at bandit's rear to maintain lock. If the target plane turns to face the missile, the missile loses its lock.

Gun and Rockets

Purpose The gun and rockets can be used for air-to-air and air-to-ground attacks, though the rockets are really meant for air-to-ground attacks. Although one or two unwary MiGs were shot down by rockets, they are nowhere near as accurate as the gun. Rockets are further described under air-to-ground weapons.

Selection Since the gun is either an A-A or A-G weapon, you can press either **[Enter]** or **[Backspace]** until Guns comes up in the display box and the GUN light comes on.

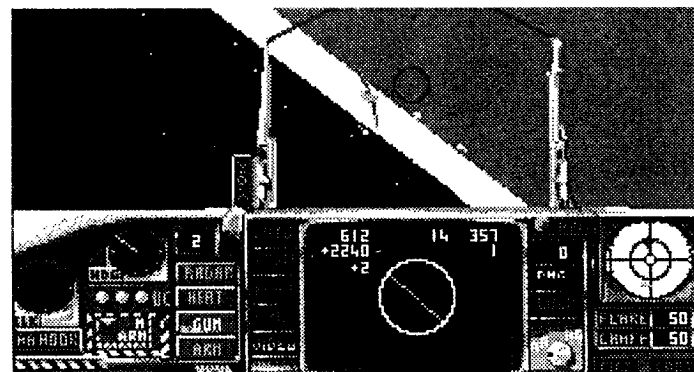

Aiming Guns should only be selected when the target is in visible range. Find your target with the threat indicator and any reports you receive from Red Crown and your wingman. When it is within 800 yards, you have a chance of hitting it. You have no instruments to help you. Just fill the screen with the Bandit and press **[Spacebar]**. Unless you are right on top of the bandit, be sure to aim where you think he will be, not where he is when you shoot.

Notes The Phantom you are flying is fitted with an M61A1 internally mounted rotary cannon. This gun, which fires at a rate of 100 rounds/second, was fitted to the Air Force's F-4E. Navy F-4J's carried the M61A1 in a gun pod if they carried any gun at all. However, we felt that if you are playing an air-to-air simulation, you should have the joy of blasting enemy aircraft with your gun. Certainly a lot of Navy pilots wished they had one.

If you want the real feel of being a Navy pilot in an F-4J, don't use the gun. Alternately, select "Limited Arms" from the **OPTIONS** menu (the default selection for players flying as Lt. Commander, Commander and Captain) and your ammunition readout will show that you have no ammunition for the gun. However, this also restricts the number of missiles and other stores you can carry.

BOMBING MISSIONS

Intruder Missions

The Intruder is an all-weather low-level bomber, so most of its deployment was in system drops at night and/or in filthy weather. Many of its drops were at low level (500 ft) at about 500 KTS and consisted entirely of following the DIANE steering instructions.

Normal Strike Missions

These would usually just be a section of one or two aircraft with no covering fighters (who couldn't operate well in those conditions, anyway). These were not flown to Hanoi or the Hai Phong docks but usually to Vinh or some isolated target.

If the target could actually be acquired visually, the Intruders would dive bomb in pairs.

Alpha Strike

If an Alpha Strike is called, all flyable aircraft on the carrier go to divide the enemy's firepower. These are usually day strikes, and everything is dropped in 60 seconds. All attackers dive bomb; the lead rolls, then everybody follows at two-second intervals so everybody is slightly offset.

Dive Bombing

The secret of dive bombing success is all in where you put the cross hairs or, in the case of the Phantom, the gun circle.

On the Intruder, the center is 1% mils (milliradians) diameter. The lines are 1% mils wide. A mil is 1 foot in 1,000 feet. So, as a rule of thumb on a 45° dive at 6,000 feet, you can see a ten foot diameter circle on the ground. Using this technique, you should be able to get a bomb close enough to almost any target.

Stephen Coonts' Technique

Roll out at 15,000 feet.

Go into a 40° dive-look at gyro.

Pickle the target at 6,000 feet-500 KTS.

The aircraft datum line (ADL) is an imaginary baseline extending from the nose of the plane toward your direction of travel. There is no instrument to show it. Set the mils setting to 115 mils to account for the bombsight's optical displacement from the ADL.

Coming out of the roll, wings level, point at the target with the ADL. Make correction for wind-no jinking from now on. Need lg flight on release. Cross hairs track towards the target: release when the cross hairs are on target-except for wind correction.

BOMBING TECHNIQUES

There are three methods for bombing using the iron bombs that haven't changed in basic construction (except in potency) since World War II. Only two of the methods are available for the Phantom, direct and dive toss; DIANE is also available to the Intruder.

Using DIANE

The DIANE is the heart of the A-6. It is both a navigation and a bombing device. In operation, the radar screen of the A-6 looks like the picture to the right.

The tripod indicates the direction to the next waypoint. Think of it as the highway ahead of you on a trip. If the centerline moves away from straight ahead, turn the plane to follow the centerline. The horizontal line running across the screen indicates the horizon.

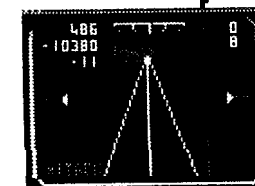
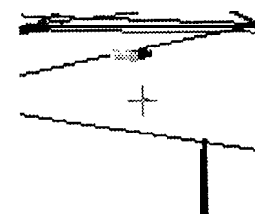
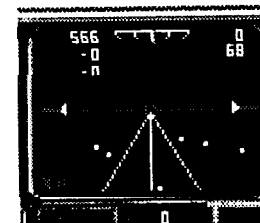
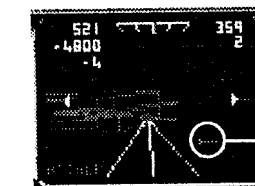

Figure 1. Approach



When the square at the top of the tripod moves off the bottom of the screen, select to set the DIANE for the next waypoint.

When ATTACK appears at the bottom of the screen, you're at the target. Press to go to the Weapon Select Screen. Select whatever iron bombs you are carrying with , select Ripple for the bomb release method with the , and DIANE for your bomb release method with .

Dive toward the target from 10,000-15,000 feet or fly level at that height. The square at the top of the tripod fills in and follows the picture on the radar screen. At the same time, a horizontal bar appears on the right side of the screen (see Figure 2). When that bar hits the bottom of the screen, hit .

Note that the horizon line has disappeared from the screen. This is because the plane is diving on the target.

If the plane was keeping a level approach, the horizon line might still be on the screen. However, the tripod would be focused on the target because its function is to show the point the plane is going to, not the direction of the plane's travel.

Horizontal Bar

Figure 2.

Using Direct

This is very difficult and takes a great deal of practice. The simplest method is a straight approach toward the target.

Before starting the attack, you need to choose the release parameters: speed, height and angle of dive.

From this selection, you can find the mil setting in the tables on pages 130-131.

For instance, for 450 KTS, an altitude of 9,000 feet and a dive angle of 60°, the mil setting is 119.

In the cockpit the mil setting is achieved using **I** and **M**. **Shift** can be used in conjunction with these keys for

a faster change. As the keys are pressed, you should see the aiming sight in the simple HUD (Head Up Display) move up and down. The actual mil reading is shown on the display below the radar screen. When you are not using this method of bombing, the display reads "0."

Set the mils as shown in the example above. Approach the target at about 9,500 feet and a speed of 400-420 KTS. If using keyboard flight controls, use the sensitivity keys, **F3** and **F4**, to change the sensitivity to maximum. When the range figure in the upper right of the screen hits one mile, push the stick forward quickly and get the sights on the target.

Coordination is needed here because you must hit **Spacebar** when the sight is on the target, the altitude is 9,000 feet, the speed is 450 KTS, and the dive angle is 60°. The dive angle should be taken care of by diving at a range of one mile. Direct attack is difficult and easy to miss by many feet, so it is a good idea to ripple the bombs to get the best chance to hit.

Practice this many times at junior officer levels before trying it with all the complications of higher level play.

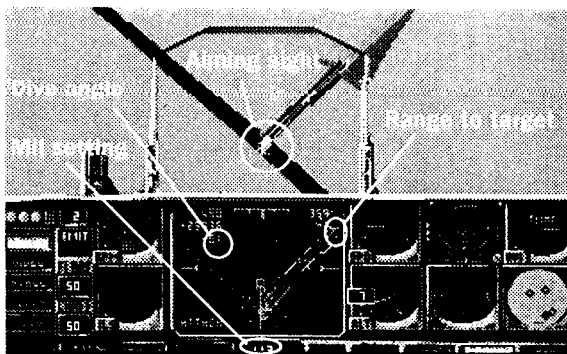
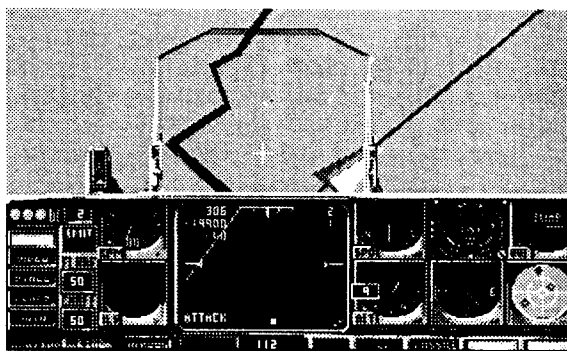

Using Dive-Toss

The setup for dive toss is very similar to direct dive bombing. Circle the target at 10,000-15,000 ft and then turn and dive towards the target.

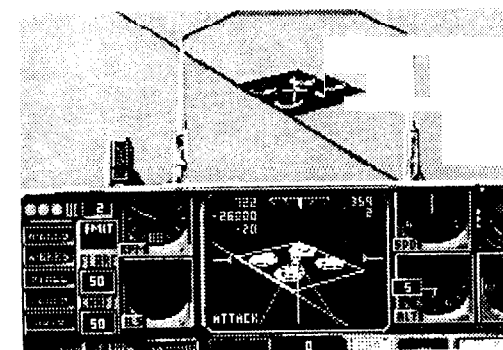
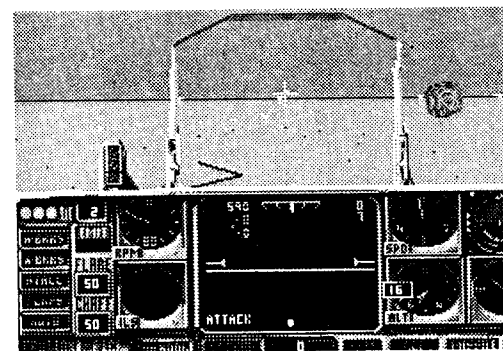

When your wings are brought level after turning towards the target, point directly at the target. The bombsight should be directly over the target.

Press **Spacebar** and pull Up. The bombs are released automatically.

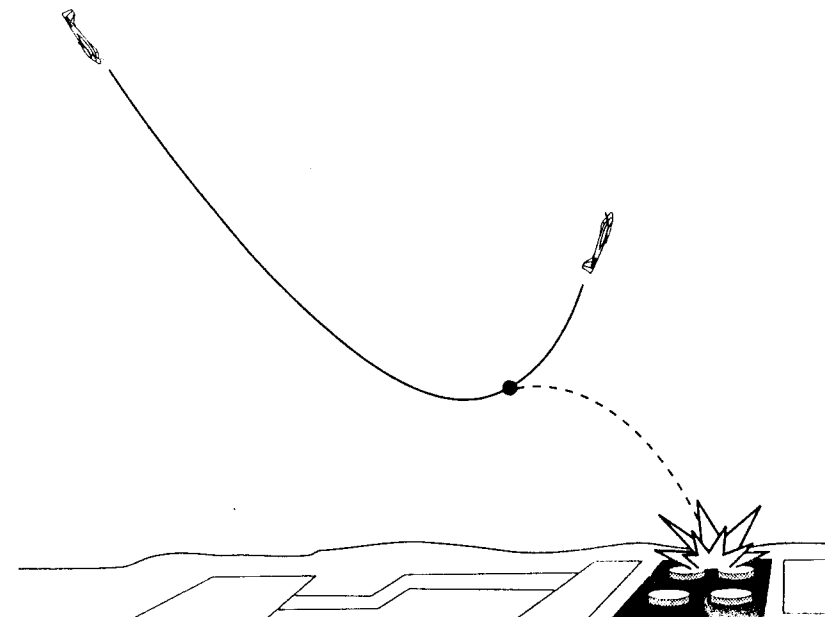

MIL DETERMINATION TABLES

Dive Bomb Mil Settings — Free Fall

Speed: 450 Kts

Height (feet)	DIVE ANGLE											
	000's	60	55	50	45	40	35	30	25	20	15	10
1	42	48	53	58	63	67	72	78	86	98	114	
2	55	64	72	80	89	98	108	119	134	152	175	
3	67	78	88	100	111	124	137	153	172	194	220	
4	77	90	103	117	131	146	163	182	204	228	256	
5	87	102	117	133	149	167	186	207	231	258	286	
6	96	112	129	147	165	185	206	230	255	283	312	
7	104	122	141	160	180	202	225	249	277	305	334	
8	112	131	151	172	194	217	241	268	296	325	354	
9	119	140	161	183	206	231	256	284	313	343	371	
10	125	147	170	193	218	243	271	299	329	359	387	
11	132	155	179	203	229	255	284	313	344	374	401	
12	138	162	187	212	239	267	296	326	357	388	414	
13	143	168	194	221	248	277	307	338	370	400	426	
14	149	175	201	229	257	287	318	349	381	412	437	
15	154	181	208	236	266	296	328	360	392	423	447	

Dive Bomb Mil Settings — Free Fall

Speed: 500 Kts

Height (feet)	DIVE ANGLE											
	000's	60	55	50	45	40	35	30	25	20	15	10
1	39	45	49	53	57	61	65	69	76	85	100	
2	50	58	65	72	79	87	95	105	117	133	154	
3	60	70	79	89	99	109	121	135	151	171	196	
4	69	81	92	104	116	129	144	161	180	203	229	
5	78	91	104	118	139	148	164	183	205	230	258	
6	86	100	115	130	147	164	183	204	227	254	282	
7	93	109	125	142	160	179	200	222	247	275	304	
8	100	117	135	153	173	193	215	239	266	294	323	
9	106	125	144	163	184	206	229	255	282	311	340	
10	112	132	152	173	195	218	243	269	298	327	356	
11	118	139	160	182	205	229	255	283	312	342	370	
12	124	145	168	191	215	240	267	295	325	355	383	
13	129	151	175	199	224	250	278	307	337	367	395	
14	134	157	181	206	232	259	288	318	348	379	406	
15	139	163	188	214	240	268	297	328	359	390	416	

Dive Bomb Mil Settings — Retarded Fall

Speed: 450 Kts

Height (feet)	DIVE ANGLE											
	000's	60	55	50	45	40	35	30	25	20	15	10
1	98	110	120	128	134	137	140	141	143	147	155	
2	110	125	138	149	159	168	176	184	194	206	221	
3	121	138	153	168	181	194	206	219	234	250	269	
4	130	149	167	184	200	216	232	249	266	286	307	
5	139	160	180	199	218	236	255	274	294	316	338	
6	147	169	191	212	233	254	275	296	319	342	364	
7	154	178	202	225	247	270	292	316	340	364	386	
8	161	186	211	236	260	284	309	334	359	384	405	
9	168	194	220	246	272	297	323	349	376	401	422	
10	173	201	229	256	283	310	337	364	391	417	437	
11	179	208	236	265	293	321	349	377	405	431	451	
12	184	214	244	273	302	331	361	390	418	444	463	
13	189	220	251	281	311	341	371	401	430	456	474	
14	194	226	257	288	319	350	381	412	441	467	484	
15	199	231	263	295	327	359	390	421	451	477	494	

Dive Bomb Mil Settings — Retarded Fall

Speed: 500 Kts

Height (feet)	DIVE ANGLE											
	000's	60	55	50	45	40	35	30	25	20	15	10
1	96	107	116	123	128	131	132	132	131	133	139	
2	106	119	131	141	150	157	163	169	176	185	199	
3	115	130	145	157	169	180	190	200	212	226	244	
4	123	140	157	172	186	200	213	227	242	259	279	
5	131	150	168	185	201	217	233	250	268	288	309	
6	138	158	178	197	215	234	252	271	291	312	334	
7	144	166	187	208	228	248	268	289	311	334	356	
8	150	174	196	218	240	262	283	306	329	353	375	
9	156	181	205	228	251	274	297	323	345	370	392	
10	162	187	212	237	261	286	310	335	360	385	407	
11	167	193	219	245	271	296	322	348	374	400	421	
12	172	199	226	253	280	306	333	360	387	413	433	
13	176	205	233	260	288	316	343	371	399	424	444	
14	181	210	239	267	296	325	353	382	410	436	455	
15	185	215	245	274	304	333	362	391	420	446	465	

AIR-TO-GROUND WEAPONS

Both aircraft carry the following weapons and use them in the same way.

AGM-45A Shrike

Purpose The Shrike homes in on active radar, making it ideal for attacking AAA and SAM radar targeting and control centers.

Selection Press until AGM 45A comes up in the display box. On the F-4, the arm light comes on too.

Aiming When a light red blip appears on the threat indicator, it is a ground threat; in addition, the threat displays should have the *missile* or AAA light flashing. A click can be heard every time the number of dots on the threat indicator changes.

Get the blip on the threat indicator to 12 o'clock. The Shrike will lock after about five seconds. When the LOCK light comes on use to release the missile. The missile will guide itself to the target unless the radar station stops transmitting.

Notes Canny Vietnamese AA operators will turn off their radar if they think a Shrike has been launched at them. (This happens at the "High Enemy Activity" setting on the OPTIONS menu.) A Shrike will not always destroy a site. It is good practice to follow up, while the site is quiet, with a Walleye or a ripple of iron bombs. You can even strafe with guns or rockets.

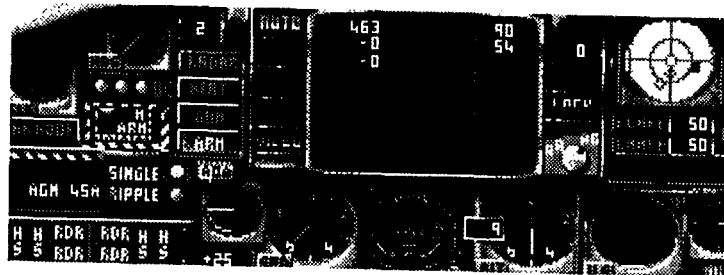

AGM-78 Standard

Purpose The Standard homes in on random radar and continues on its set flight path when the radar turns off.

Selection Press until AGM 78 comes up in the display box. On the F-4, the arm light comes on too.

Aiming See AGM-45A above.

Notes Vietnamese AA operators who turned off their radars were very surprised when these smart bombs continued to glide in on their already established path. Again, it is always a good idea to follow up with bombs, guns or rockets.

AGM-62 Walleye

Purpose The Hughes Walleye is a small laser-guided missile. It can be relied on to hit its target if it is used correctly, but it is not particularly big and cannot be relied on to take out a large or hard target.

Selection In the A-6, press until Walleye comes up in the display box and a camera view appears on the radar screen.

Aiming Point the aircraft in the direction of the target. In the A-6, you should see the target on the radar screen. This is a TV view, as the camera is located in the nose of the missile. The F-4 does not show this.

The A-6 has two modes of operation for the Walleye: (1) Fixed Sight and (2) Variable Sight. Toggle between them by pressing .

Fixed Sight provides cross hairs on the TV screen that match wherever the cross hairs on the HUD are placed. The only exception is that the TV screen cross hair cannot be drawn above the horizon and so, as you climb, the cross hair is pushed down the screen. This means that you should not shoot as the solution is unreliable.

Point the aircraft at the target so that the cross hairs overlay the target. Press . The locked light should come on and the figures on the screen show the range and bearing to the target. The cross hair on the screen will now move with the target. If you are not satisfied with the lock, press to release the lock. See page 37 for an example of a fixed sight approach.

Variable Sight gives you HUD and TV cross hairs that do not match. The TV cross hair is locked to a point on the ground. As the aircraft moves, the cross hair continues to overlay the point on the ground. The point the cross hair is locked to can be changed with the following keys.

Move up screen	<input type="text" value="I"/>
Move left	<input type="text" value="J"/>
Move right	<input type="text" value="L"/>
Move down screen	<input type="text" value="M"/>

Using with these keys speeds up the motion.

When the cross hairs overlay the target, switch on the master arm () and press .

The first time you press "pickles" the target by locking the radar onto it. The LOCKED light below the radar screen lights up. Press a second time to fire the missile at its target.

In the F-4 The ARM light comes on and there is no camera picture. The F-4 essentially uses a fixed sight, your HUD gunsight. The radar is use less for sighting. On the F-4, the same LOCK light you use with the Sparrow also lights up with the Walleye. However, if the F-4 does not have a target to lock on, it shoots the missile when you first press , so be sure of your target.

LGB Paveway

Purpose The Paveway is a laser-guided bomb (LGB). It consists of a laser sensor attached to an MK84 (see page 136). It is very similar to the Walleye except that it is a bomb, not a missile. It packs a greater punch but must be released over the target.

Selection Press **[Backspace]** until Paveway comes up in the display box and a camera view appears on the radar screen. On the F-4, the ARM light comes on.

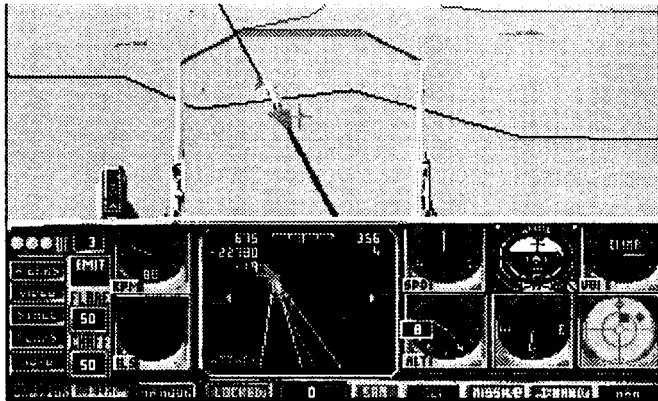

Aiming The aiming method is virtually identical to that used for the Walleye. The A-6 has the same two methods of aiming. (The method pictured above is the variable sight method; note that the cross hair is not in the center of the radar screen.) The Paveway packs a much bigger punch than the Walleye, but the Walleye is easier to aim. This is because the Paveway does not have any propulsion and therefore can only maneuver in a small envelope. Thus, you must dive more steeply over your target when using the Paveway. The harder the targets you select on the **OPTIONS** menu, the higher the dive angle you must attain before releasing this weapon.

Notes While the method of shooting the Paveway is identical to the Walleye for shooting purposes, the actual method of target designation is different. When Paveway is selected, a friendly plane illuminates the target with laser light. The pilot must release the bomb so that it can pick up the reflected light from the target. This is called "getting the bomb down the chute" or "in the basket."

The need to get a friendly to illuminate, or "paint" the target, is simulated in the game with the LOCKED light. If the LOCKED light is on, the illuminating plane has done its job and the bomb will guide. If your wingman has been shot down, you will not get a LOCKED light. Bombs released without the LOCKED light act like the iron bombs described on the next pages.

LAUSA ZUNI Rockets

Purpose Rockets are meant to put a lot of firepower into a relatively small area at once. They can be used against personnel and lightly armed vehicles, but have no penetration against tanks.

Selection Rockets are considered air-to-ground weapons, so press **[Backspace]** until LAU 3A comes up in the display box, the arm light comes on, and the cone circle disappears on the radar screen.

Aiming Rockets have an effective range of about one mile, only select them when you have a target in visual range. For the purpose of aiming, rockets can be treated the same as a gun. Just aim the plane at the target and press **[Spacebar]**. If the target is moving, lead it.

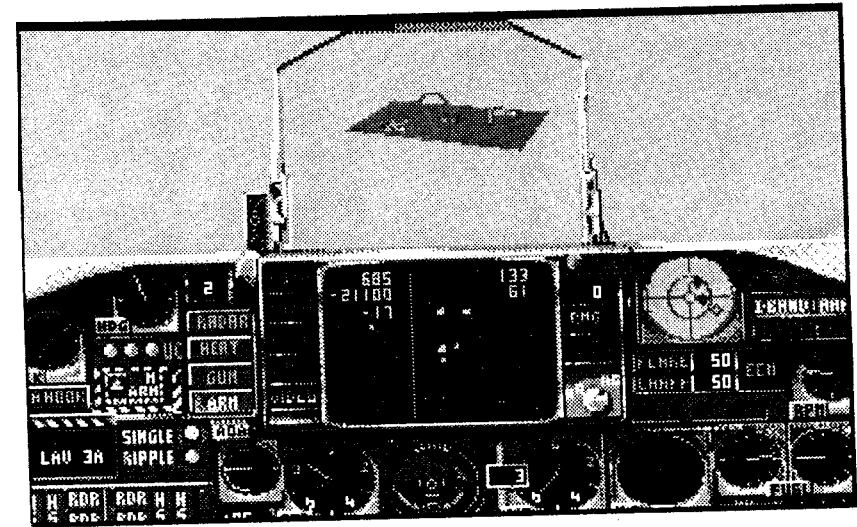

Notes The LAU-3A rocket pod holds 19 folding fin aircraft rockets (FFAR). They are usually fired in bursts of four or five. While they are considered an air-to-ground weapon, there is nothing to stop you from letting some fly in the direction of a bandit. As an A-6 pilot you could certainly give a MIG a surprise. If a rocket hits a MIG, it can shoot it down.

Iron Bombs

Purpose Iron bombs have changed little since the Second World War. The size has increased and some sophistication has been added (such as the Snakeye's retarded fall), but essentially the iron bomb still falls from the airplane with nothing influencing its motion but gravity and wind drag.

Selection Press until either MK82, MK82S, MK83, MK84 or CBU-52 comes up in the display box. On the F-4, the ARM light comes on. Toggle (or) on the number pad to select the bombing mode of DIANE, Direct or Dive Toss. Toggle (or) on the number pad to select either Single or Ripple release. If using a Tandy 1000 computer, use the number pad and , not the designated and keys.

Aiming MK82, MK83, MK84, MK82S (Snakeyes) and CBU-52s can be released Single or on Ripple. Ripple means all weapons on a station are released at one second intervals. The following bomb release methods are available:

DIANE	A-6 only
Direct	A-6 and F-4
Dive Toss	A-6 and F-4

See pages 127-129 for directions on using these methods.

Notes The MK82 is the standard all-purpose free-fall 500 lb bomb and still has many uses-especially in rapid-release mode.

The MK83 is a standard ordnance 1,000 lb bomb. For best results release around 7,000 ft while diving at 45°.

The MK84 is a general purpose 2,000 lb bomb giving a high PK. It should be released at over 2,000 feet to avoid being hit by the blast.

The MK82S Snakeye is a retarded free-fall version of the MK82 all-purpose bomb for use in low-level attacks.

CBU-52 Cluster Bomb Units are actually containers of several smaller bombs that scatter and explode, making it an ideal weapon for personnel-intensive areas such as SAM sites. They are commonly used by Wild Weasel attacks after a Shrike or Standard has silenced the radar installation.

Single or Ripple: Select Ripple for soft targets spread over a large area. Choose Single when pinpoint accurate bombing is required. On hearing the bombs release, press to go to missile view. You will then see the bombs fly towards the target.

Correct Approach: You can approach the target directly and point the nose at the target by pushing forward on the stick to drop the nose of the aircraft. In reality, this creates negative g's and can cause a "redout" in which the pilot has no control of the aircraft. This can be simulated by selecting "Blackout/Redout On" from the **OPTIONS** menu.

To avoid this redout problem, a bomber pilot will normally circle the target, go into a 135° roll, pull back on the stick and then straighten up to point straight down at the target.

PART IX: CARRIER LANDINGS

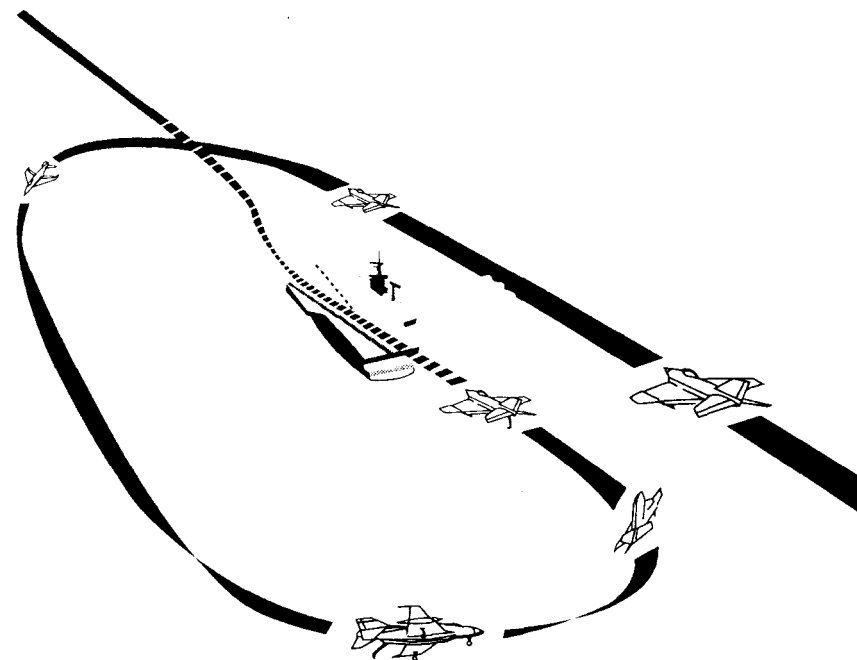

...like trying to land an elephant on a postage stamp!

-Common saying of carrier pilots

Landing on an aircraft carrier is a difficult task at best. It requires alertness and concentration—just the thing at the end of a trying mission.

Some say it doesn't matter where the bombs go, but you'd better get the landing right. Everybody is watching and you get marked.

In this simulation, you get real marks for each manual landing. (There is no mark for taking the easy way out and using "End Mission" from the **FILE** menu or the autopilot to land the plane.) If you land the plane manually and go to the Debriefing screen, you get one of three marks displayed in brackets under the entry "Duty Pilot Landings":

Green OK	Speed and orientation good on touchdown
Black No comment	Speed and orientation not dangerous
Red Dangerous	Hook or gear up on touchdown or just plain bad landing

If you are having a bad day or if your aircraft is damaged call for the net ((Shift)H) for "Help"). This is a barrier erected over the wires to stop an aircraft which cannot hook an arrestor wire.

If you go for the net, you do not get a landing mark.

INSTRUMENTATION TO HELP WITH LANDING

The Meatball

Press (F7) (the ACLS key) to activate the "meatball." This is a column on the port (left) side of the carrier with two fixed horizontal green lights and one movable vertical yellow light. If the yellow light is in line with the green lights, then you are on the glide slope and you are descending at the required pitch of 3°. If the yellow light is above the green ones, then you are above the glide slope. If the yellow light is below the green ones, then you are below the glide slope.

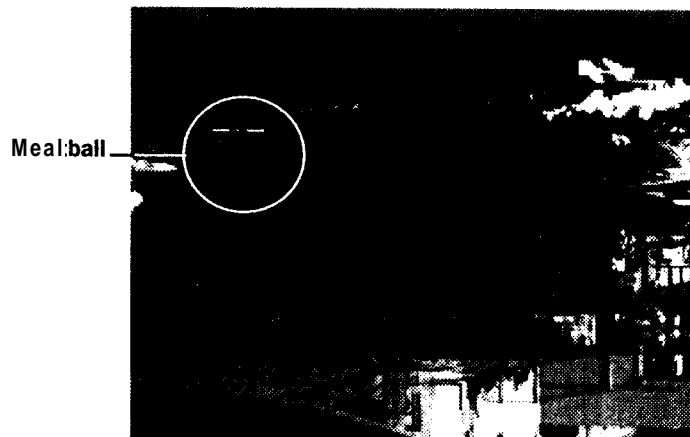

AOA Indexer

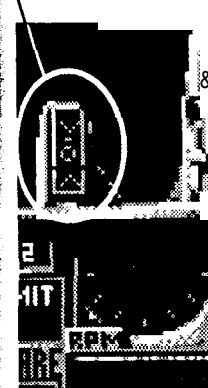

This is a column on the left of the aircraft optical sight. It is activated by pressing (F7). There are three lights: a downward arrow at the top, a circle in the middle, and an upward arrow at the bottom. The circle is illuminated if your approach speed is correct. Correct approach speed for the F-4 is 156 KTS, for the A-6 is 118 KTS.

If the top light is illuminated, then you are going too slow. If both the top and center lights are on, then your approach speed is a little too slow. This means that your angle of attack (closely related to speed) is out by half a unit.

The bottom light indicates that speed is too high.

If you have pressed (F7) and no light is on, you are coming in at an uncorrectable speed. Go around and try again.

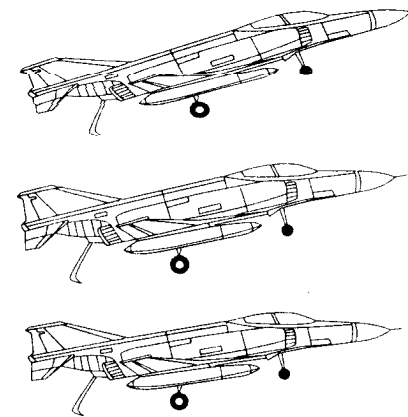

Indexing AOA to Pitch

If you are using an outside view to watch your plane land, you can tell if you are too fast or too slow by the approach pitch of the plane. If the nose is too high, you are not going fast enough to keep your tail up. Speed up. If the nose is too low, you are going too fast to drop your hook properly. Slow down.



Press (F7) to activate the AOA Indexer and ACLS (see next page).

GETTING HOME

Manually

Use (F5) or (F6) to go an outside view and toggle (Shift)J until the waypoint entry says "Carrier." You will see the distance and bearing to the carrier from your current heading (this is known as the offset). Change your heading to match the bearing.

By Autopilot

Turn off the autopilot, go to an outside screen and use (J) to toggle the waypoints to "Land." Then turn the autopilot on again. This only works for the A-6, an F-4 in autopilot continues to chase bandits instead of going home.

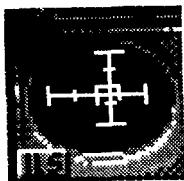

Automatic Carrier Landing System (ACLS) Indicator

The ACLS Indicator assists you when making an instrument landing (called "following the needle"). The ACLS has ^{NO} principal components: the Glide Slope Deviation (GSD) scale and the Localizer Deviation (LD) scale.

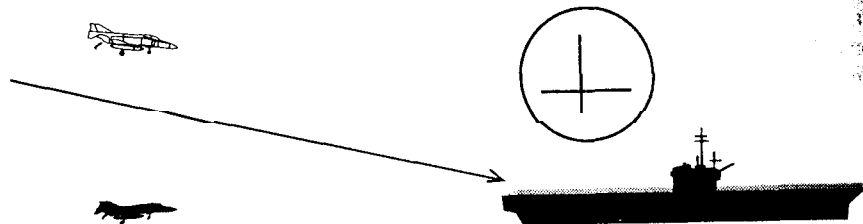

The GSD scale indicates the extent to which you are above or below the "landing beam" (an imaginary beam projected from the flight deck). The higher you are above the beam, the lower the GSD scale. The scale is centered when the landing approach is correct.

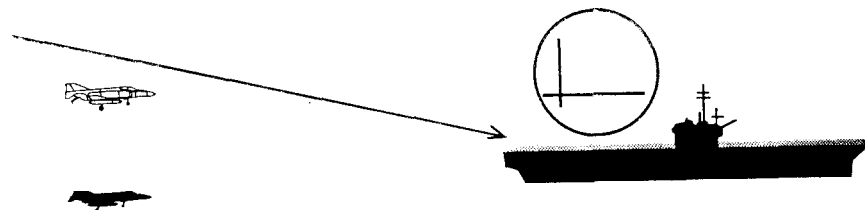

The LD scale indicates the extent to which you are to the left or right of the deck. If you are left of the flight deck, the LD scale will be to the right of center, and vice versa. The scale is centered when the landing approach is correct.

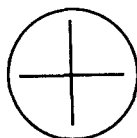

You need to control two additional parameters for a perfect landing: angle of attack (see page 139 under "AOA Indexer") and heading (see page 139 under "Manually").

PRACTICE LANDINGS

- Select CAG Briefing. This brings up the target selection screen.
- Press [L] and use [Backspace] or [Delete] to erase the operation name shown. Type in TESTLAND. This is a shortened mission which takes you away from the carrier and then brings you back to do the required circuit before automatically landing. Ignore the "Error: No Target" message. You are here for practice, not a score.

First, play this mission through on automatic to see the circuit.

- Put the aircraft on accelerated mode until it is heading back towards the carrier. You should see the carrier at about 8 miles.

The aircraft will fly over the carrier, drop the landing gear and break left. A course of 270 is then achieved, and the carrier should be seen on the left. When the starboard escort frigate is just still visible in the left side view, the flaps are lowered and the aircraft turns again toward the carrier. When the aircraft has lined up the approach, the hook is lowered. During the final approach on automatic, note the ACLS, the meatball, the heading on the radar screen, etc. Stay in the outside view (F5) for the landing and you should see the arrestor wire engage.

Now try a manual landing. You can turn to manual at any part of a circuit by pressing [A] to disengage the autopilot. Initially, it is a good idea to just practice the final approach.

- You will need a combination of stick and RPM adjustments to:

- Keep the meatball's lights in line.
- Keep the ACLS lines centered into a perfect cross.
- Keep the speed correct (118 for A-6 and 154 for F-4).
- Keep the pitch correct.

- If the meatball lights are in line and your pitch is 3" (as shown on the AOA indexer or the radar screen), then you are in good shape.

When you drop your landing gear, your viewpoint out of the front of the cockpit changes to a lower-looking one. This gives you a viewpoint more in common with what a carrier pilot is actually looking at when making a carrier landing.



Some Useful Data

In the A-6 the landing speed is 118 KTS. The carrier's combined speed and windspeed across the deck is 40 KTS (on a good day) so the relative speed is 78 KTS.

To achieve 118 KTS power down to 80% RPM and use airbrakes. When the desired speed is obtained, put the RPM back up to 88%. On the RPM dial, 80% is at the 6 o'clock position.

The VSI (Vertical Speed Indicator) should be 650 ft/min. From this data we can produce the following table:

Miles Out	Desired Height
1	575 feet
2	1075 feet
3	1575 feet
etc.	

PART X: AIRCRAFT SPECIFICATIONS

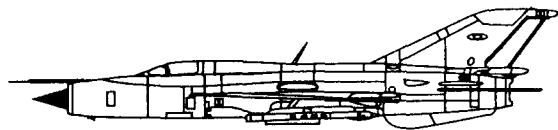
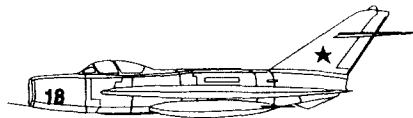
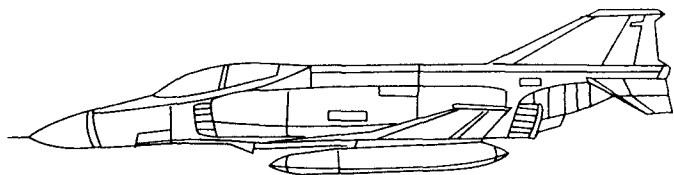
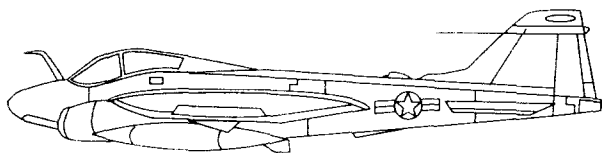

A-6 INTRUDER

The A-1 Skyraider and A-4 Skyhawk were very successful attack aircraft, but even before it had to deal with the storm-tossed seas and cloudy skies of Vietnam, the United States Navy realized that it needed a heavy carrier-based bomber that would carry a bigger bomb load and be able to make blind passes at a target in any weather and at any time.

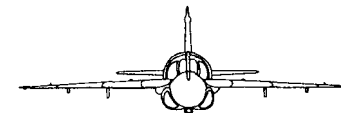

The Grumman A-6A Intruder first flew in April 1960. The airframe was so successful that it was adapted to the KA-6D aerial tanker and the EA-6B Prowler electronic warfare plane. Initially, the electronics suite of the Intruder was too fragile for its mission. The plane spent most of its time in maintenance. However, the then new science of microelectronics in the 1960s led to a complete replacement of its original avionics into a much smaller and more efficient setup capable of sustained missions.

The A-6A was the first operational version of the Intruder. It was followed by the A-66 (a Shrike-carrying SAM suppression craft) and A-6C (specially configured to interdict the Ho Chi Minh trail) as well as the aforementioned tanker. In this simulation you fly the A-6A, which was replaced in service by the A-6E right after Linebacker in 1972. Now in 1990, 28 years later, the A-6E is still in operation with the United States Navy and Marine Corps, though its replacement, the A-6E TRAM is steadily replacing it. Current versions can carry the Harpoon anti-ship missile.

The Intruder is a dedicated bomber. Unlike other naval attack craft, such as the A-4 Skyhawk and A-7 Corsair, the Intruder carries no air-to-air weaponry. It relies on stealth and its ability to fly in any weather to get past defending aircraft, deliver its bombs, and get home.

The "heart" of the A-6 is DIANE, the Digital integrated Attack Navigation Equipment. It is rumored that the name, belonging to the daughter of one of the design engineers, came first and the designation later. This combination of equipment, which has undergone regular upgrades over the years, essentially consists of a search radar, a tracking radar, and an inertial navigation system. These let the plane navigate in all weathers, seek out and track both mobile and immobile targets, and map terrain ahead. Initial flight checking was a nightmare, but by 1965 Intruders were dropping their 18,000 lb bomb loads wherever asked for in North and South Vietnam. The Intruder is just barely subsonic: its builders concentrated on a plane capable of flying low and bombing accurately.

They got it.

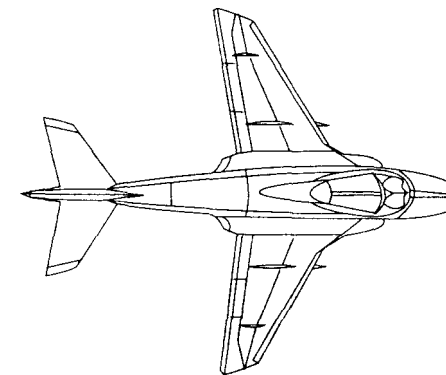

F-4 PHANTOM II

The F-4 Phantom II started as an enhanced version of McDonnell Aircraft Company's F-3H Demon. It was originally designed as an attack fighter but in 1955 the Navy said that a heavy two-seater attack plane was not the answer to their prayers. However, a fleet defense interceptor that could fly off an aircraft carrier, remain on station 250 miles from the carrier, intercept enemy MiGs and not come home for up to three hours was just what the Navy doctor ordered. Oh yes, guns are obsolete, just put on Sparrow radar-guided missiles.

We can do that, said McDonnell. And sure enough, they did.

The Air Force, also looking for a fighter, picked up on the new airplane and joined the Navy in setting an impressive list of records.

The Phantom II (the Phantom I was a little-used McDonnell design from the Korean era) became the fighter of choice for both services in Vietnam. They went through many changes over the years, but the versions most commonly in service during the Vietnam era were the Navy's F-4B and F-4J and the Air Force's F-4C, F-4D, and the gun-armed F-4E.

The Phantom was a long-ranged fighter capable of bursts of speed over Mach 2. Though not an agile aircraft, in the hands of a good pilot it could, and did, give a good account of itself against the far more agile MiGs employed by the North Vietnamese.

The Phantom you fly in this simulation is basically a version F-4J. This is the Navy F-4 available during the Linebacker campaign. However, there are some modifications similar to those for the Air Force F-4E, also present during Linebacker. For instance, an M61 20mm cannon and self-aiming Paveway smart bombs have been fitted.

One interesting difference between the Navy and Air Force versions of the F-4 is that the Radar Intercept Officer (RIO), also called the GIB (Guy In Back), in the Navy plane was a dedicated radar watcher and weapon shooter. In the Air Force, the GIB had a stick and could fly the plane in a pinch. The Navy jets had a hole in the deck where the stick was in the Air Force plane.

The Phantoms had a long career as the principal fighter of the U.S. Navy, though they have now been phased out in favor of the F-14 Tomcat and F/A-18 Hornet. Some Marine reconnaissance units still use the RF-4B reconnaissance fighter, and the Air Force still uses the RF-4C recon fighter, but most of these have been retired. There are many Phantoms still in use by foreign air forces.

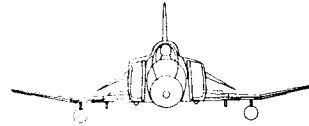
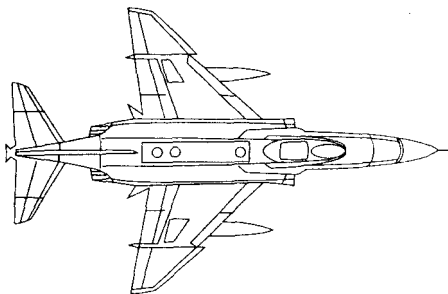

MiG-21

The MiG-21 was originally developed as an interceptor to meet the threat of the American B-47 and B-52. It was the first Soviet Mach 2 fighter. The first of the Soviet fighters to use a delta wing instead of the swept wing of the MiG-17 and 19, it was a durable fighter that is still used in various configurations in many air forces today.

The design requirements called for a small fighter (actually smaller than the MiG-19), and this caused a reduction in endurance as the plane just had no room for large internal fuel tanks. The first operational design, the MiG-21F, was found to be deficient in radar efficiency. To accommodate a larger radar system, the designers had to relinquish the initially-required aircraft cannon.

The MiG-21PF was sent to North Vietnam and met its first real operational test. They rapidly discovered that it suffered from a deficiency in armament. The radar made little difference.

Its total offensive weaponry consisted of four air-to-air missiles of dubious utility. Once they were fired, the plane was useless. In many ways, the MiG-17, despite its relative antiquity, was more successful in its basic mission of stopping bomber raids because it had greater endurance and packed a couple of rapid-fire cannons.

Almost immediately, the Soviets began a remake of the MiG-21 which was designated the MiG-21PFMA. The major additions were two extra pylons that could carry missiles or extra fuel tanks (thus increasing either firepower or endurance), and an internal gun, a 23mm two-barrelled weapon that takes up an amazingly small amount of space. Unfortunately, its lack of barrel length seemed to reduce its range and accuracy. The additional missile carrying capacity and gun increased the MiG-21's kill ratio, but not by a significant amount. This was the fighter used in North Vietnam (along with its retrofitted relatives) from 1968 through the rest of the war.

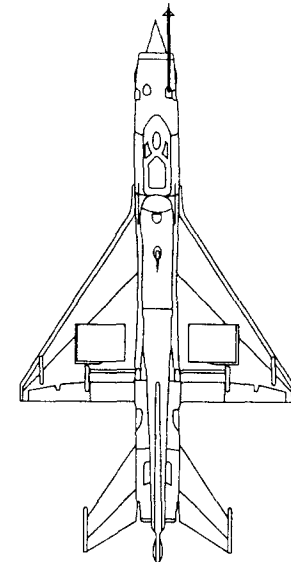
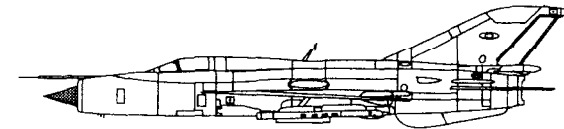
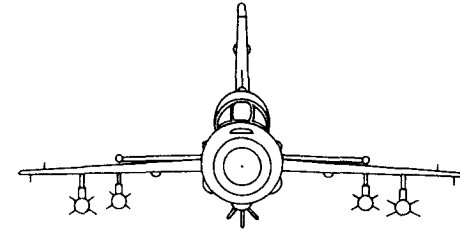

MiG-19

The MiG-19 was developed to provide a truly supersonic fighter for the Soviet air force. It became the first such fighter in the world.

It was equipped with missiles and a limited-performance radar and was among the last fighters given to the People's Republic of China before their split with the Soviet Union in 1960. The Chinese reverse-engineered the fighter into their highly successful Shenyang J-6, which they have imported in one form or another all over the world.

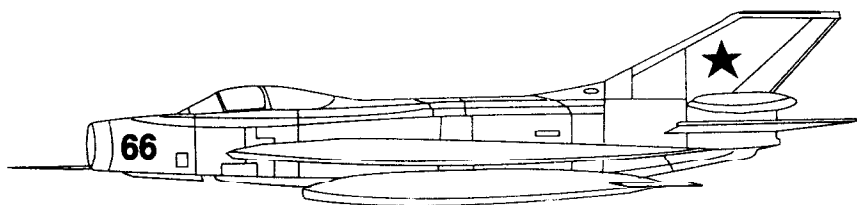
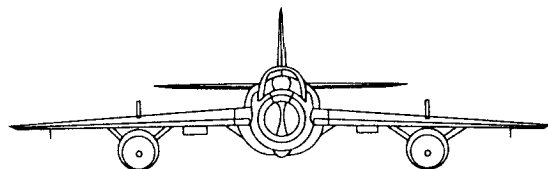

The MiG-19 in North Vietnam was no more maneuverable than its predecessor and its radar gave it away, so it was little improvement over the MiG-17 in the air against the American forces.

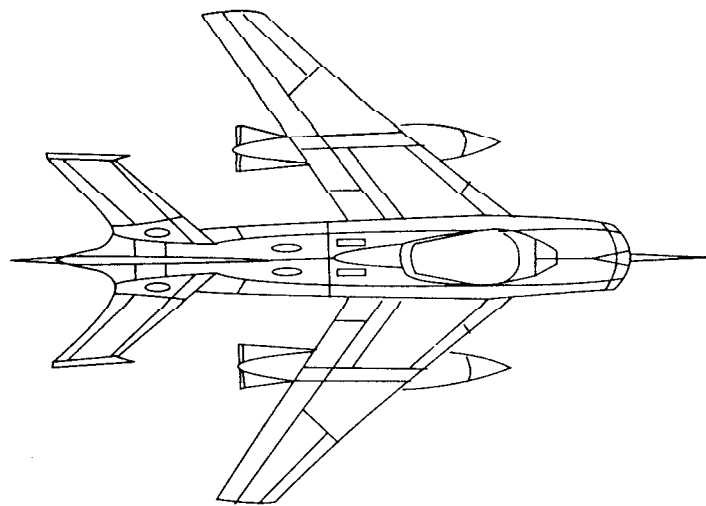

MiG-17

Production of the MiG-17 was authorized in mid-1951. It was a modification of the MiG-15 that gave many United Nations pilots fits in Korea. By 1960 it was considered obsolete and was being replaced in the Soviet air force by the MiG-19, but it still proved a dangerous adversary in Vietnam ten years later.

Part of its danger to opposing aircraft was in its obsolescence. Its minimal radar (completely missing in many of the North Vietnam fighters) meant that it did not show up on RWR, and its maneuverability let it turn inside of any American fighter in the sky. Since all it had to do was force American bombers to abort their bombing missions, its very presence was sometimes enough to complete its primary mission, which means it was very successful in its task.

The MiG-17 also has the distinction of being the first missile armed Russian fighter. This was the favorite aircraft of the notorious "Colonel Toon," who was credited with shooting down 13 American planes.

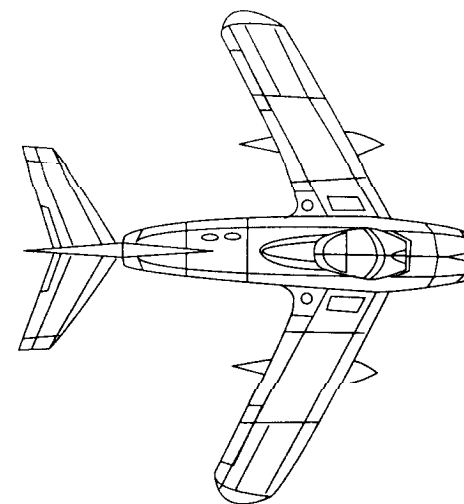
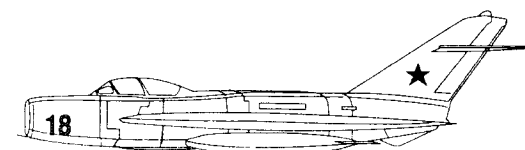
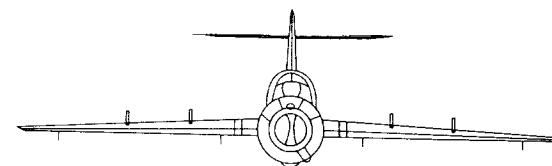

SUMMARY COMPARISONS

	Intruder	Phantom	MiG-21	MiG-19	MiG-17
Max Speed (mph)	644	1,500	1,385	902	710
Max Ceiling (feet)	42,400	55,000	60,000	58,725	52,500
Max Ordnance (lb)	18,000	58,000	20,725	19,180	14,440
		16,000	3,307	2,200	1,650

PART XI: THE NAVAL AIR WAR OVER VIETNAM

A SUMMARY
BY
GILMAN LOUIE

The Gulf of Tonkin

The war in Vietnam began on August 2, 1964 when F-8E Crusaders from the USS *Ticonderoga* attacked North Vietnamese P-4 patrol torpedo boats off Hon Me island. The North Vietnamese PT boats had attacked the U.S. destroyer *Maddox* (DD-731), possibly confusing the destroyer with one of the South Vietnamese patrol boats which had earlier shelled a radar station on Hon Me Island and a radio transmitter on Hon Ngu island. After the *Maddox* fired three warning shots, the Vietnamese craft launched torpedoes. All shots missed. After taking machine gun fire, the *Maddox* radioed for air support. Four F-8E Crusaders intercepted the patrol boats and sank one of the P-4 boats with gunfire and Zuni rockets.

On the night of August 4, 1964, the *Maddox* and USS *Turner Joy* picked up three high-speed surface radar contacts. Two A-1 Skyraiders were launched from the *Ticonderoga* to intercept the probable boat contacts and to provide aircover. Because of bad weather, the A-1s never confirmed the presence of enemy patrol craft. This apparent hostile action against U.S. destroyers on patrol in international waters led to the passing of the Gulf of Tonkin Resolution on August 10th by Congress. This resolution gave the President the power to "take all necessary measures to repel any armed attack against the forces of the United States and to prevent further aggression."

Escalation

The Vietnam conflict started as a series of United States retaliations against the North Vietnamese government for specific actions. In retaliation for the attack on the *Maddox*, 64 aircraft were launched on August 5, 1964 from the USS *Ticonderoga* and USS *Constellation* to attack enemy PT boat bases in Operation Pierce Arrow. These aircraft carriers, part of Task Force 77, were stationed in the Gulf of Tonkin just south of Hainan. This position became known as Yankee Station.

On December 24, 1964, 73 servicemen were either killed or injured when the Brink Hotel Bachelor Officers' Quarter in Saigon was bombed. The President authorized Operation Flaming Dart One, which targeted enemy barracks at Dong Hoi and Vit Thu Lu. The Communists responded by bombing the Bachelor Enlisted Quarters at Qhi Nhon on February 10, 1965, which killed or wounded 44 U.S. personnel. Again, the U.S. retaliated the next day with Flaming Dart Two which attacked the Chanh barracks.

Action brought reaction. Targets and mission profiles were approved in Washington before each mission. Targets were assigned by the Joint Chiefs of Staff (JCS) with approval from the President and Secretary of Defense. On February 13, 1965 President Johnson authorized operation Rolling Thunder. Rolling Thunder tasked both the Navy and Air Force with bombing missions north of the DMZ (Demilitarized Zone) to the outskirts of Hanoi. The goal of Rolling Thunder was to force North Vietnam to the peace table by demonstrating U.S. firepower and threatening their capital. The object was to bomb military targets and to avoid

civilian or foreign casualties. U.S. Admiral Grant Sharp said, "It [Rolling Thunder] does not seek to inflict maximum damage on the enemy. instead, it is a precise application of military pressure for the specific purpose of halting aggression in South Vietnam."

Rules of Engagement

Rules of Engagement were established to control the conflict. Only targets that had been pre-approved could be bombed. Targets would be submitted to the Pentagon, and they would recommend the targets to the JCS and the Secretary of Defense. Only the President could officially add targets to the list. The number of sorties and mission profiles, including the type of ordnance, was decided in Washington. This elaborate approval process was designed to control and limit the conflict by placing control in Washington rather than with the local commanders. This policy failed.

The Rules of Engagement frustrated the naval aviators. Several rules were established. Aircraft were not allowed to bomb secondary strike targets. All unexpended ordnance had to be jettisoned at sea rather than on targets. Surface-to-air missile sites could not be attacked while under construction for fear of hurting Soviet advisors. Enemy aircraft could not be bombed while on the ground unless they were taking off. No aircraft could be attacked unless positive visual identification was made, yet the Navy's principal fighter, the F-4 Phantom, was designed as a beyond-visual-range interceptor and had no internal gun. Harbors could not be mined; ships carrying war supplies could not be bombed. Aircrews also could not attack military targets such as AAA (Anti-Aircraft Artillery) batteries on farms, rice paddies or dikes; military supply trucks parked on civilian sites; or SAM batteries within 10 miles of Hanoi. If a mission was canceled due to weather or a change in operations, the entire authorization process had to be repeated.

To make matters worse, ship commanders during the early phases of the war competed with each other to see which ship could launch the most sorties (missions). If one ship flew 125 sorties in one day, another ship tried to launch 130 sorties the next day. So instead of loading up planes with full loads to bomb several targets in one mission, several flights of planes would be launched with only one or two bombs in order to keep up the number of required sorties. Many pilots and Radar Intercept Officers (RIOs) lost their lives as others played the numbers game. As one pilot had put it, "It's crazy to let politicians run a war...it's like having the military run a country."

The Threat Grows

By the spring of 1965, the air war really began to heat up. Operation Rolling Thunder was under way, and the United States was dropping an average of 800 tons of ordnance a day. Instead of buckling under, the North Vietnamese raised



the ante by adding two new air defense weapons to its already effective AAA, the MiG and the SAM (surface-to-air missile). On April 4, 1965 the first conclusive air combat took place over Vietnam when two Air Force F-105s were shot down by MiG-17s. Then on April 5, a USS *Coral Sea* RF-8A reconnaissance plane positively confirmed the construction of the first surface-to-air missile site. The photos revealed the construction of a Soviet built SA-2 Guideline missile site 15 miles southeast of Hanoi. The SA-2 was a two stage anti-aircraft missile capable of intercepting and destroying aircraft at altitudes of over 60,000 feet.

The commander of Task Force 77, Rear Admiral Edward Outlaw, along with the commander of the 7th Air Force in Saigon, wanted to strike the SAM site quickly. Because of the Rules of Engagement, however, he was not allowed to without first going through the chain of command. A joint Air Force and Navy plan that would destroy all of the sites under construction was submitted, but permission was never given by the Joint Chiefs of Staff. On July 24, 1965 an Air Force F-4C was shot down by a SA-2 while flying target combat air patrol during an attack on the Lang Chi munitions factory. The SAMs were now operational.

The President authorized a single retaliatory strike on July 27th against two specific SAM sites (sites 6 and 7) near Hanoi. One site was destroyed, but the cost was four Air Force F-105s and one RF-101C. The Navy lost its first plane, an A-4E, to a SAM on the night of August 11th. The Navy was authorized to retaliate on August 13, 1965. Seventy-six low-level anti-SAM missions ("Iron Hand") were launched on that Black Friday. Five planes were shot down by enemy guns, two pilots were killed, and seven planes were damaged. No SAM sites were discovered or destroyed.

Enter the Intruder

The Grumman A-6A Intruder is a two-seat subsonic attack aircraft capable of delivering 16,800 pounds of ordnance at ranges of over 1,500 miles in any kind of weather, day or night. Until Vietnam, the A-6 with its multimillion dollar advanced radar and computer systems was untested. Many experts had doubts as to the ability of the A-6 to deliver its payload.

In July 1965 the VA-75 Attack Squadron aboard the USS *Independence*, better known as the Sunday Punchers, was the first Air Wing to receive the Intruder. The first mission of the Sunday Punchers was to take the Intruder to targets south of Hanoi.



This was the first Vietnam mission flown entirely by radar. Over the next several weeks, the A-6A proved its ability to hit its target in any kind of weather or time of day. The introduction of the A-6 gave the Navy its first attack aircraft that could overcome the terrible monsoons the Vietnamese weather delivered in the Tonkin Gulf.

The A-6 was so effective that Radio Hanoi claimed that American B-52 heavy bombers had attacked the Uong Bi power plants under the cover of night with 26 bombers. In reality the raid was carried out by only two Intruders. The intruder was used not only as a bomber but also served as a SAM suppressor in the 'Iron Hand' missions.

The A-6 was an effective attack aircraft, but it did come at a cost. Fifty-one Intruders were shot down in Vietnam, and the plane suffered one of the worst combat loss rates in the Navy, trailing only the propeller driven A-1 and the single-seat light attack A-4 Skyhawk in loss to flight ratio. The main threats to the A-6 were small arms and anti-aircraft automatic weapons.

iron Hand

As the war continued, the United States began to develop new tactics to deal with the growing number of North Vietnamese threats. To counter the growing SAM threat, the Navy developed an operation called "Iron Hand" to suppress the SA-2 surface-to-air missiles. These anti-SAM sorties were first flown from July 1965 to August 1965. Initially, these missions proved very costly. Several Iron Hand planes were shot down by the SAMs and even more were destroyed by AAA fire. It wasn't until October 17, 1965 that the Navy bagged its first confirmed destruction of a SAM site near Kep Air Base.

It took time for the Navy to develop adequate Iron Hand tactics. At first, planes attempted to come in below 3,000 feet to avoid the high flying SAMs. The problem was that the flights became extremely vulnerable to small arms fire and AAA. Another problem with coming in low was that the planes did not have enough energy (speed) when they had to pop-up for their attack runs. This made the attacking plane a sitting duck for AAA and small arms as the plane seemed to hang in mid-air as it popped up for its attack.

In March 1966, the Iron Hand operations became truly effective. With the introduction of the AGM-45 Shrike anti-radiation missile, the Navy had its first real anti-SAM weapon. The Shrike followed the radar beam being emitted from a SAM site. The installation of radar warning equipment (AN/APR-25 RHAW) in the aircraft along with jammers (AN/ALQ-81 ECM) and chaff dispensers (AN/ALE-29A), allowed the American planes to dive in at medium altitudes. An even more effective anti-SAM missile, the Standard, was introduced in May 1968; it was bigger, had a longer range, and was less susceptible to being fooled. The Iron Hand missions greatly reduced the effectiveness of the SAMs.

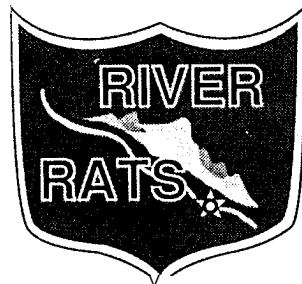

MiGCAP

The air war in Vietnam was mainly an air-to-ground affair. MiGCAP (MiG Combat Air Patrol) was an operation mainly flown by F-4 Phantom IIs from the larger Forrestal and later class carriers and

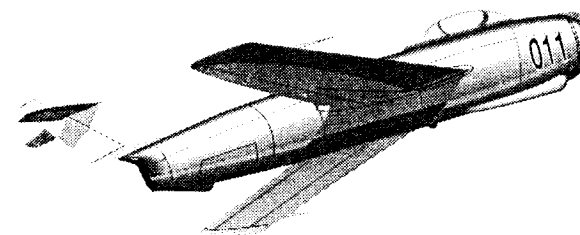

by F-8 Crusaders off of the smaller Essex and Midway class carriers. (The Midway and Coral Sea had F-4 Squadrons as well). For many, MiGCAP was a boring mission since most of the action was air-to-ground. But MiGCAP was needed to defend the attack aircraft against the MiG-17, MiG-19 and MiG-21. When the MiGs were up, things got hot.

The F-4 Phantom II was a Mach 2.5 multi-purpose interceptor and is regarded by many as the best all-around aircraft flown in Vietnam (though Navy F-8 drivers might try to argue this with you). The Navy versions, unlike the Air Force F-4E, did not have an internal gun. All of the Navy's MiG kills in the F-4 were done exclusively with missiles. The F-4 mainly carried two types of air-to-air missiles: the medium range radar-guided AIM-7 Sparrow and the short range AIM-9 Sidewinder.

The AIM-7 Sparrow was designed to intercept and destroy aircraft at distances beyond visual range (up to 14 miles). The Radar Intercept Officer (RIO), or GIB (Guy In Back), would lock onto targets with his radar and launch an AIM-7 at his prey. The F-4 must keep its radar on the target in order to guide the missile until the point of contact. Because the Rules of Engagement required aircraft to be positively identified (which usually meant visually within two miles), the effectiveness of the AIM-7 was greatly reduced. The AIM-7 accounted for only ten of the Navy Phantom's 41 kills. Only one Sparrow out of every twelve launched found its target.

The AIM-9 Sidewinder accounted for the other 31 MiG kills by Phantom drivers. The AIM-9 is a heat-seeking missile with approximately a two mile range. A pilot had to approach his target's rear end in order for the missile to lock on the heat signature of the MiG's engines. Once launched, the Sidewinder would guide itself towards the target. The Sidewinder was twice as effective as the AIM-7 with a kill every 5.5 launches.

The Navy orchestrated large attack groups consisting of bombers (A-6 Intruders, A-4 Skyhawks or A-7 Corsair IIs), Combat Air Patrol fighters (F-8 Crusaders or F-4 Phantoms), Flak Suppressors (F-8s or F-4s) and Iron Hands (A-6s, A-4s or F-8s). These flights, which could contain as many as 24 aircraft, became known as Alpha Strike missions. It was this strike package which became the standard formation for hitting targets in North Vietnam.

Top Gun

From 1965 to 1968, the F-4 Phantom's kill ratio was a lousy 2.6 to 1. The F-4 crews had bagged 13 MiGs and lost five F-4s. The naval aviator had lost his ability to dogfight, especially against the smaller and more maneuverable MiGs. By 1968, things were getting worse with the kill ratio falling below 1 to 1.

In 1968 the Naval Air System Command ordered a study to find out why our aviators were being blown out of the skies. The now famous "Ault Report" pointed out three reasons why the kill ratio had suffered. First, the air-to-air missiles did not work as advertised. Second, the Rules of Engagement neutralized any advantages our aircraft had and gave limitless advantages to the enemy. Third and most important, our pilots were poorly trained in air combat maneuvering (ACM) against dissimilar aircraft and tactics.

In 1969 a class for Navy F-4 crews began to correct these deficiencies. Three years later an independent command, the Navy Fighter Weapons School, better known as TOP GUN, was established to train crews in the art of ACM.

When the air war began to heat up again in 1972, TOP GUN F-4 pilots enjoyed a 24 to 2 kill ratio. In addition, no additional Navy attack or reconnaissance aircraft were lost to enemy MiGs. TOP GUN produced the Navy's only aces, Lt. Randy Cunningham and Lt (j.g.) Willie Driscoll. On May 10, 1972, Cunningham and Driscoll in their F-4 shot down three MiGs in one mission including the dreaded enemy ace Col. Toon flying a MiG-17. Col. Toon was credited with downing 13 American jets before meeting Cunningham and Driscoll. The dogfight that took place between these two planes is now legendary. TOP GUN had paid off.

Rolling Thunder V

The war continued to intensify through 1967 with Operation Rolling Thunder V which began on February 14, 1967. President Johnson authorized attacks against a new list of targets which included mining the Song Ca estuaries and Song Giang rivers in order to close them to barge traffic. He also ordered the bombing of the ports of Cam Pha, Hong Gai and Haiphong. In addition to this, bridges and rail networks were also destroyed, cutting off the steady supply of weapons and fuel to the North Vietnamese. Eventually, Haiphong ran out of ammunition. In 1967 the Navy alone destroyed 30 SAM sites, 187 flak batteries and dropped 955 bridges. In addition, thousands of trains, trucks and watercraft were destroyed. The Navy scored 14 MiG kills and had no less than 11 aircraft carriers on line.

Early 1968 saw the North Vietnamese striking back with two large offensives: the Tet offensive and the battle for Khe Sanh. Both efforts were repulsed. On November 1st, after feeling the pressure of the anti-war movement, President Johnson ordered the unilateral halting of bombing north of the 20th parallel except "in the areas where the



continuing enemy buildup directly threatens allied forward positions and where the movement of their troops and supplies are clearly related to that threat." President Johnson had hoped that by halting the bombing a peace dialogue between the Communists, the South Vietnamese and the United States could begin. He hoped that the cessation of hostile activity would demonstrate the United States' good faith. In reality, it eased the pressure on Hanoi and Haiphong and allowed the North Vietnamese to rearm. The Communists were committed to their cause.

After winning the 1968 presidential election, President Nixon began the gradual withdrawal of troops from Vietnam. On June 8, 1969, the U.S. withdrew 5,000 troops from South Vietnam. Peace talks began in Paris in August 1969.

Bombing began in both Laos and Cambodia in an attempt to stop the steady supply of arms to the Viet Cong into South Vietnam. The main targets were trucks and transportation routes along the infamous Ho Chi Minh Trail. This bombing continued through 1970 with very little success because the supplies needed to be cut off at their source, the harbors. The anti-truck campaign did not halt the transportation of arms since the Viet Cong found new ways of moving weapons under the cover of night and jungle to avoid the U.S. air raids.

Linebacker

On March 30, 1972 North Vietnam launched a massive all-out spring offensive across the Demilitarized Zone into South Vietnam. Ceasefire talks in Paris between the President's National Security Advisor, Henry Kissinger, and the North Vietnamese representative, Le Duc Tho, broke off. Tho felt he had the advantage because of the protests in the United States over the war and, with the new spring offensive, he thought that victory over the South was imminent.

In response, on April 7, 1972, President Nixon authorized the Navy, for the first time during the Vietnam war, to mine Haiphong and other North Vietnamese ports. In addition, an all-out effort was made to bomb all of the North's supply lines. B-52s began their first raids over Hanoi and Haiphong on April 17th. The Navy also launched strikes into Hanoi and Haiphong. All traffic stopped, with the exception of that across the Chinese borders. Between May and September, the Navy launched an average of 4,000 day and night sorties a month. In that same period of time, the North launched nearly 2,000 SAMs and fired thousands of rounds of AAA, resulting in the destruction of 28 U.S. aircraft. By the end of the campaign, the North ran out of ammunition. Not a single AAA shell nor SAM missile was fired at U.S. aircraft. On October 23rd the Communists asked for a ceasefire.

On October 24th, the United States halted bombing above the 20th Parallel as a peace gesture (although bombing of supply lines south of the 20th Parallel continued at an unprecedented rate). Linebacker I had ended.

After the bombing stopped, the Communists refused to deal in earnest and used the halt to resupply and rebuild. To make matters worse, the South, after accusing the U.S. of cutting a separate deal with the North, sabotaged the peace discussions by making 69 major changes in the initial peace proposal.

Operation Linebacker II commenced on December 18, 1972 when President Nixon resumed the bombing of Hanoi and mining of Haiphong. Nixon was determined to force the North back to the bargaining tables. For the next eleven days, with the exception of Christmas and New Year's Day, aircraft from the America, Enterprise, Midway, Oriskany, Ranger and Saratoga attacked a variety of targets: petroleum, oil and lubricant (POL) storage areas, airfields, SAM and AAA sites, rail, road, shipyards, port facilities, and enemy troop emplacements. All told, the Navy flew 505 day and night sorties against the North in the 11 days. On January 15, 1973 combat operations in the North were halted.

On January 27, 1973 representatives from the U.S., South Vietnam, North Vietnam and Viet Cong signed the "Agreement on Ending the War and Restoring the Peace in Vietnam." All offensive operations ceased, the mines were removed from Haiphong harbor (Operation Endsweep), and preparations for the return of 144 downed U.S. pilots (Operation Homecoming) were made. Thirty-five aviators had died in captivity.

Four months after Congress voted in June 1973 to end all U.S. combat activities in or over Southeast Asia, the North Vietnamese Central Committee adopted a resolution to conduct a revolutionary war to destroy the enemy and liberate the South. Because of the War Powers Resolution Act which made it illegal to commit U.S. forces for more than 60 days without congressional approval, the U.S. did not respond.

On April 30, 1975 Saigon, along with all of South Vietnam, fell to the North.

The Score

U.S. naval combat action officially terminated on August 15, 1973 when Congress mandated the end of all combat involvement in Southeast Asia. The ten years and five days after the Gulf of Tonkin Resolution cost the Navy the lives of 377 naval aviators, 179 prisoners of war and 64 missing in action. Another 205 officers and men had also been lost during major fires aboard three carriers. Operational accidents claimed 316 planes, while 538 aircraft had been lost in combat. Anti-aircraft artillery accounted for 37% of the Navy's aircraft losses, 18% to small arms fire (machine guns and rifles), and 15% to surface-to-air missiles (SAMs). Only 2% of the Navy's losses were to MiG interceptors.

The Navy used 21 carriers during the Vietnam war and spent a total of 9,178 days in the Gulf of Tonkin. Between the Navy, Marines and Air Force, the United States dropped a total of 7.4 million tons of bombs in Southeast Asia. Between 1964 and 1973, the Navy flew a total of 785,000 fixed-wing combat sorties. The Navy and Marines shot down a total of 61 enemy aircraft of which 59 were MiGs (39 MiG-17's, 2 MiG-19s and 18 MiG-21s). The Navy enjoyed a 56 to 10 fighter vs. fighter score against the North Vietnamese.

PART XII: GLOSSARY AND ABBREVIATIONS

The following entries are meant to give you a general feeling for the military and somewhat more informal jargon of being a pilot in Southeast Asia in the late 1960s and early 1970s. Some game terms are included.

AAA	Anti-Aircraft Artillery.
A-A	Air-to-Air, also written as A2A or just AA.
AB	Afterburner. Acceleration over and above normal military power, achieved by spraying fuel into the back of the engine. The F-4 has this capability, as do most of the MiGs. The A-6 has no afterburner.
ACLS	Automatic Carrier Landing System.
ACM	Air Combat Maneuvering. Essentially the art of dogfighting.
ADI	Attitude Director Indicator. This gauge registers your plane's position relative to the horizon as it rolls and pitches.
ADL	Aircraft Datum Line indicates direction of travel on the DIANE.
AGM	Air-to-Ground Missile. The designation for such weapons as the Walleye, meant to be fired from an aircraft at a ground target.
AI	Airborne Intercept.
AIM	Air Interdiction Missile. Otherwise known as an AAM (Air-to-Air Missile). It is meant to be used by one aircraft to knock down another. In this game, the Sidewinder and Sparrow are AIMS.
Aircrew	The pilot and his crewmate (RIO for the Phantom and B/N for the Intruder).
Airspeed	There are two forms of airspeed. IAS (Indicated Airspeed) is the speed usually presented to the pilot. It should be fairly accurate at sea level. Since the measurement is a function of air density, however, it becomes less and less accurate at increased altitudes. TAS (True Airspeed) is the air speed corrected for altitude effects.
Air Wing	A group of aircraft aboard a carrier led by a senior commander.
Alpha Strike	An airstrike using every available aircraft in a carrier's complement against one target or a closely related cluster of targets.
Altimeter	A gauge that tells the pilot what altitude he is at.
Angels	Altitude in 1,000s of feet. "Black Eagle is at Angels 23" means that he is at 23,000 feet.
AOA	Angle of Attack.
AOA Indexer	Used primarily to assist you in landing. It consists of a bank of three lights just to the left of your HUD. If the top light is on, your AOA is too high. If the bottom light is on, your AOA is too low. If the middle light is on, you are at the perfect AOA.

AOA Indicator	This gauge displays the AOA in degrees. The zero position is at 9 o'clock and 30° at 12 o'clock. Increased AOA is represented by counterclockwise movement of the needle.
Arrestor Net	A net strung over the arrestor wires when it is thought that the incoming aircraft may not be able to make a normal landing.
ASI	Air Speed Indicator. This dial is calibrated in knots TAS. The zero position is at 12 o'clock. One revolution represents 1,200 KTS on the F4 and 600 KTS on the A-6.
Atoll	A Russian air-to-air missile very similar to the Sidewinder (q.v.).
Ault Report	The report of the commission to investigate why the Navy had such a poor record in air-to-air combat in the 1960s. Reaction to the findings of this report created the TOP GUN school.
Autopilot	A device that will keep the plane at the same altitude, speed and heading it was set for. The autopilot in this game is far more sophisticated than any autopilot currently available.
Bandit	A bogey (q.v.) that has been identified as a foe.
Bank	To turn left or right in the air by changing your wing attitude.
BARCAP	BARrier Combat Air Patrol. Fighters who defend a carrier against intruding aircraft.
Bearing	The compass heading from one point to another, based on the current heading (q.v.) of the viewpoint.
Bingo Fuel	An indication that your plane has just enough fuel to get home.
Blackout	Losing vision or consciousness from pulling excess positive g's.
BN or B/N	The Bombardier/Navigator in an A-6 or A-3.
Bogey	An unidentified aircraft that may be friend or foe.
Bolter	To abort a carrier landing and circle around for another try.
Bomb Run	(1) Mission code for the actual run to drop bombs on a target; (2) The act of attacking a target with bombs.
Break	A sharp turn of 6+ g's taken to avoid a SAM or MiG on your tail.
Clag	Bad, mucky weather.
CAG	Commander Air Group. An archaic title deriving from when all a carrier's planes were known as its Air Group. Well before the Vietnamese war, the carrier planes had been redesignated as Air Wings, but the name is still in use. The CAG works with his pilots to plan their missions and to lead these

	missions. In this simulation, you act as CAG by planning all the steps of the mission and then flying the mission.
Callsigns	These are used instead of real names for security reasons. Just about anything seems to go. However, callsigns were grouped into families, e.g.: birds (hawk, condor, bluebird, falcon), cars (Olds, etc.) and trees (oak, pine). Transmissions start with callsign and number in section, e.g.: "Oak1, Execute, Execute, Papa Orange." As well as being leader of a section, Oak1 is also the Strike Force Commander. His message indicates that the operation is on: go for the primary target.
CAP	Combat Air Patrol. The job of keeping hostile planes away. CAP was originally the duty of guarding the aircraft carrier against attack. During the Vietnam war, there were several different forms of CAP. See <i>BARCAP</i> , <i>MIGCAP</i> , <i>RESCAP</i> and <i>TARCAP</i>
Cat	Catapult.
Celling	The level of the clouds. A "ceiling at 3,000 feet" means there is a total cloud cover at 3,000 feet above sea level.
CBU	Cluster Bomb Unit.
Chaff	Packages of tiny foil strips dropped from a plane that confuse radar-guided missiles
Charlie	Slang for Viet Cong, from the military alphabet "Victor Charlie."
Climb Rate	The number of feet a plane can climb in one minute of climbing. This is usually expressed as a positive number. As a negative number it is effectively the dive rate of the aircraft.
co	Commanding Officer.
Cockpit	The space where the aircrew sits and manipulates the airplane.
Cobb	To open up all the way, as in "cobb the throttle."
Colonel Toon	Legendary Vietnamese ace credited with shooting down 13 American aircraft before he was shot down by Lt. Randy Cunningham and his RIO, Willie Driscoll.
COMED	Combined Map/Electronic Display. The central display on the control panel that can be toggled between a map showing target locations and your plane's location. It also displays the various air-to-ground and air-to-air weapons.
Compass	A device that always shows the current heading of the airplane.
Connie	The nickname for the aircraft carrier USS <i>Constellation</i> .

Court-Martial	A military court that tries defendants under the code of military justice. It is said that a court-martial is the best court if you are innocent and the worst if you are guilty. Those accused of breaking the Rules of Engagement were tried by a court-martial.
CV and CVA	Aircraft Carrier and Aircraft Carrier (Attack).
Debriefing	The act of being questioned after a mission so the Intelligence officers can learn everything possible about the current state of the enemy and the results of the mission.
Det.	Detachment. This refers to a small number of planes not big enough to form a squadron. They were formed primarily because of heavy combat losses in Vietnam.
DIANE	Digital Integrated Attack Navigation Equipment. This is the collection of radars and inertial guidance systems that allows the A-6 to find its targets and bomb them without ever seeing them in the darkest night or foulest weather.
Dixie Station	Sea area off of South Vietnam used by U.S. Navy carriers for attacking targets in South Vietnam, Laos and Cambodia.
DMZ	Demilitarized Zone. Buffer between North and South Vietnam.
Dogfight	A fight between two airplanes. So named because the constant circling of the combatants resembled circling dogs in the eyes of some of the early writers about air combat.
"Doubie Ugly	A term of derision or endearment for the F-4 Phantom II.
Driver	A person piloting (rather than navigating) a two-seat aircraft.
Duty Roster	The list of which pilots are flying and what their missions are.
ECM	Electronic Counter-Measures. A pod that is designed to fool ground-based SAM sites and the radar of MiG fighters.
Egress	Flying out of the target area.
Enemy	Someone who is trying to kill you, and whom you have orders to kill.
Escort	Ground cover mission, meant to keep the ground-based defenses from interfering with a bomb run as well as fending off enemy fighters. Equal priority goes into covering AAA, SAM and GCI sites, as well as incoming MiGs.
EW	Electronic Warning, as in Electronic Warning Indicator.
Feet wet/Feet dry	Feet wet indicates that a pilot is currently over water, while feet dry refers to a pilot reaching land.
FFAR	Folding-Fin Aircraft Rockets. See Zuni Rockets.
Flaps	Control surfaces on the wing and tail that slow down a plane.

Flares	Magnesium-based packages dropped from a plane which are designed to fool heat-seeking missiles.
"Fly your needles"	A command to fly by your instrument readings rather than by visual sighting.
FOD	Foreign Object Damage. Something that has hit the plane. It can be shrapnel, a bird, a thrown rock or whatever. It usually refers to objects sucked into the jet intake.
Free Fall	The state of falling without power. Usually referring to the fall of a bomb after it has been released by a bomber, but it can refer to anyone or anything falling without something to retard the fall (such as a parachute, airfoils, etc.). See <i>Retarded Fall</i> .
Friendly	As a noun, this designates another person or vehicle who is on your side, even if he is an Air Force or Marine pilot.
g	A measurement of the acceleration force being applied to the plane and its pilot. 1g is equivalent to a plane flying straight and level. Too many g's and a pilot blacks out.
G-suit	A full body suit designed to compress the fat tissue on a pilot's legs and abdomen. It was created so that a pilot's blood would not pool to the bottom of his body during high g maneuvers.
GBU	Guided Bomb Unit (a laser-guided bomb).
GCA	Ground Control Approach.
GCI (or GIC)	Ground Intercept Control. The radar units that track incoming aircraft and relay the information to AAA and SAM sites. The usual North Vietnam SAM site consists of SAMs at the points of a star shape with a GCI unit at the center of the star.
Gear, Landing	The wheels you use to land on a ship or ground runway.
GIB	Guy In Back, originally Air Force slang for the RIO (Navy title) or WSO (Air Force title) in the back seat of an F-4.
Ground Fire	Attack by projectile weapons from the ground. Usually refers to soldiers using normal infantry weapons rather than AAA.
Grumman	The company that built the A-6 Intruder.
GSD	Glide Slope Deviation. The horizontal scale on the ACLS. When landing, the further you are to the right of the carrier, the further the GSD scale moves to the left and vice versa. See <i>LD</i> .
"Go dirty"	Lowering your gears, flaps, etc. before landing your plane.
Guideline	NATO code for the Russian SA-2 SAM.
Gulf of Tonkin	Body of water between Vietnam and China's Hainan island.
Haiphong	Principal port of North Vietnam. Pilots gritted their teeth as they passed over this port and saw dozens of foreign vessels

Hangfire	A failure or delay of an article of ordnance after being triggered.
Hanoi	Capital of North Vietnam and current capital of Vietnam.
Hanoi Hilton	Nickname for Hoa Lo prison in the center of Hanoi. Built by the French during their occupation, it was always heavily guarded and almost completely escape proof.
Heading	The compass direction any vehicle (ship, plane, tank, etc.) would move if it travelled straight ahead from its current position. It can refer to either a moving or a stationary vehicle.
Heartbreak Hotel	A pilot's first stop when brought to the Hoa Lo prison. See <i>Hanoi Hilton</i> .
Hot Start	A start that exceeds normal starting temperatures.
HSI	Horizontal Situation Indicator.
HUD	Head Up Display. A transparent panel in the forward wind-screen that shows a projected display of vital information so the pilot can look at it and what is outside his cockpit at the same time. In the Vietnam era HUDs only held gunsights.
IFF	Identification Friend or Foe. A radio device mounted on an aircraft that broadcasts the identity of the aircraft.
ILS	Instrument Landing System. Another term for the ACLS (q.v.).
Ingress	Flying into the target area.
Intruder	The official title of the Navy's A-6 all-weather attack bomber.
IR	Infrared.
Iron Hand	Navy term for an attack mission on AAA and SAM sites.
Iron Triangle	An extremely defended area located between Thanh Hoa, Haiphong and Hanoi.
Jamming	The attempt to confuse enemy radar and other electronics so that they cannot find you as a target.
Jinking	Flying an irregular flight path to prevent enemy gunners from targeting your plane.
JP	Jet Petroleum. The standard term for jet fuel.
JP-5	Jet fuel used by the Navy. It has a density of 7 pounds per gallon. Pilots worry about how many pounds of fuel they have because thrust is a function based on mass of fuel, not volume of fuel.
K	The initial designation code for an airplane used as a mid-air tanker. The tanker version of the A-6 is known as the KA-6D.
KIAS	Knots Indicated Air Speed.

Korat AFB	A principal Air Force Phantom base in Thailand.
Knot (KTS)	Short for speed of nautical mile per hour or, loosely, one nautical mile. Approximately 6,076 feet: equivalent to 1.15 miles.
LD	Localizer Deviation. The vertical scale on the ACLS. The higher you are when landing on the carrier, the lower the LD slides down the scale and vice versa. See GSD.
LGB	Laser-Guided Bomb.
Linebacker	The code name of the last, and greatest, air attack against North Vietnam. There were actually two Linebackers, one following the other.
Lock-on	The act of acquiring a target with the radar and setting the radar to track the target.
LOX	Liquid Oxygen.
LSC	Landing Signal Officer. The officer whose job it is to guide pilots to a landing on the aircraft carrier. Commonly called "Paddles."
Mach	Unit of speed measurement equal to the speed of sound.
Manual	To bomb a target or attack or land on a carrier without using the avionics (frequently because the avionics are not working). In essence doing everything "by hand."
Master Arm	The switch that activates the plane's weapons. Under the Rules of Engagement (q.v.), pilots were forbidden to have their master arm switch on within certain distances of Hanoi or Haiphong.
Meatball	Glide slope image of mirror landing system (MLS).
MIA	Missing In Action. This is the designation for any serviceman who is not known to have died in his plane but has also not been located in an enemy prison camp.
MiG	Any product of the Mikoyan/Guryevich design works that designs many Soviet fighters (though not all of them). Commonly, any enemy fighter is called a MiG whether it is or not.
MiGCAP	MiG Combat Air Patrol. MiGCAP generally consisted of a group of fighters away from the target area. They were placed between the target and the nearest airfields for the purpose of intercepting MiGs before they could reach the target area.
Mil	1) Military Power-100% thrust of an airplane's engines without using the afterburners. 2) Milliradian-An angular measurement which subtends one foot at 1,000 feet (17.45 mils = 1").

Mission	The individual task of one element or section (usually two planes) of an operation (q.v.). Missions generally have special titles such as Wild Weasel, MiGCAP, etc.
M61A1	Official designation of the 20mm cannon mounted on some F-4s and many other American fighter and attack planes.
Multiple Weapon Selection Panel	The area on the control panel on which the pilot can select the weapons he wants to use in any situation.
Nautical mile	Also known as a "knot." Abbreviated as NM.
Nuggets	Airmen on their first tour of duty.
"On your six"	Common call from a wingman telling you that you have an enemy fighter or a SAM directly behind your plane.
Operation	A number of sections of aircraft with a common objective. Usually the objective is the destruction of a primary and a secondary target
Ordies	The men who load the ordnance onto a plane.
Ordnance	Weaponry.
Over the beach	The plane is over land. See Feet dry.
Paveway	A "smart bomb" that uses a TV guidance system similar to that used by the Walleye (q.v.).
Phantom II	The official name of the Air Force's F-4 fighter.
"Phantom Man"	A cartoon figure adopted by the Navy as a method of pointing out important information in their Phantom Flight Manuals.
Pitch	The movement of a plane on the vertical axis.
PK	Probability of Kill.
POW	Prisoner of War.
psi	Pounds per square inch.
Pullup Light	A light on the control panel of the Phantom that warns the pilot that he must pull up or crash.
RADAR	RAdio Detection And Ranging.
Red Crown	Radar picket ship in the Tonkin Gulf. It called all MiG radar sightings and tried to cover SAMs as well. If MiGs flew "in the weeds," then Red Crown could not always spot them. While Red Crown was very useful, it was not 100% reliable.
Recce	A reconnaissance flight. See RF.
Redout	A loss of vision or consciousness as the result of pulling too many negative g's.
RESCAP	REScue Combat Air Patrol. These are the guys whose job it is to find downed pilots and pull them out of the jungle or ocean.

ff	Radio frequency (always shown in lower case letters).
RF	Reconnaissance Fighter.
Retarded Fall	The fall of any object that is being slowed down for any reason. For bombing, it refers to the fall of a bomb that is slowed down by vanes or parachutes.
RIO	Radar Intercept Officer. The official title of the GIB (Guy in Back), the second man in the two-seater Phantom. His responsibility was different than the Air Force's WSO, a copilot who could, and often did, fly the plane. The RIO's sole job is watching for threats (either enemy fighters or SAMs) and running the radar.
River Rat	A pilot who has flown in combat north of the Red River.
Rockeye	Anti-tank bomb.
Rookie	Pilot without prior combat flight experience.
RPM	Revolutions Per Minute. The percentage of power being produced by your engine. See <i>Thrust</i> .
Rules of Engagement	The rules that pilots and bombardiers had to follow over the skies of Vietnam. Breaking the rules meant a court-martial.
SA-2	The official designation of the Russian Guideline SAM.
Saigon	Capital of South Vietnam. Now known as Ho Chi Minh City.
SAM	Surface-to-Air Missile.
SAR	Search And Rescue mission.
Section	One or two planes used to perform a mission. See <i>Wing</i> .
Shrike	An anti-radar missile primarily fired at enemy SAM sites.
Shuttle	The device that attaches the front wheel of a carrier aircraft to the catapult that launches it.
Sidewinder	The AIM-9 heat-seeking air-to-air missile.
Sierra Hotel	The military identifiers for the letters "s" and "h." Extremely good pilots are known as being Sh*t Hot, or Sierra Hotel.
Six o'clock	The directly behind position. It's a good position for an attacker, a very bad one for the target.
SL	Sea Level.
Slats	A movable auxiliary airfoil attached to the leading edge of a wing which can act as a flap.
Sortie	A launch of several aircraft to perform one or more operations.
Sparrow	The AIM-7 radar-guided air-to-air missile.
Stall	A loss of control of the plane due to low airspeed or radical maneuvering in high attitudes.
Stick	A pilot's directional control.

Stores	The bomb load and other devices carried by an aircraft.
Super Engines	When using super engines, the plane's airspeed is directly related to the percentage of RPM applied and no other factors (such as air density or mechanical fatigue) are involved.
TACAN	TACTical Air Navigation system.
TARCAP	TARget Combat Air Patrol. A group of fighters which patrolled around the target area during an air strike.
TAS	True Air Speed. The equivalent airspeed corrected for error due to altitude and temperature (air density).
Threat Indicator	A passive radar display on the control panel which gives the relative positions of various enemies and friendlies for about a 30 mile radius. Also known as the RWR (q.v.).
Thrust	RPM. The amount of power being produced by your aircraft's engine. The terms Thrust and RPM are used interchangeably.
Top Gun	The common name of the Navy ACM school.
Trap	Arrested (by hook and arresting wire) landing.
Twelve o'clock	The straight-ahead position. Where you want an enemy to be.
Up North	Slang term for North Vietnam.
VI (or VSI)	Vertical Velocity Indicator (Vertical Speed Indicator). This dial measures climb and descent rate in 1,000s of feet per minute. The zero position is at 9 o'clock. Climb is represented by a clockwise movement of the needle. For example, 3 o'clock represents 6,000 feet/minute.
Walleye	A TV-guided air-to-ground bomb where the pilot can see his target through the missile's TV camera.
Waypoints	Points on the map frequently associated with landmarks or ship positions; a plane's course is plotted between these points.
Wild Weasel	A ground attack on SAM and AAA sites. Planes flying Wild Weasel strikes generally carried ECM pods. See <i>Iron Hand</i> .
Winchester	If an airplane is "Winchester," it is depleted of weapons.
Wing	Two planes used to carry out a mission. See <i>Section</i> .
Wing Leader	The lead plane in a wing.
Wingman	The following plane in a wing. He mirrors the wing leader and covers him if necessary.
Yankee Station	Sea area in the Gulf of Tonkin where the U.S. Navy stationed its carriers to launch air attacks into North Vietnam.
Zoo	Nickname for the POW camp on the southwest edge of Hanoi.
Zuni Rockets	Unguided LAU-3A FFAR (q.v.) rockets carried for attacking ground targets. At least one was brought down by Zunis.

KEYBOARD LAYOUT

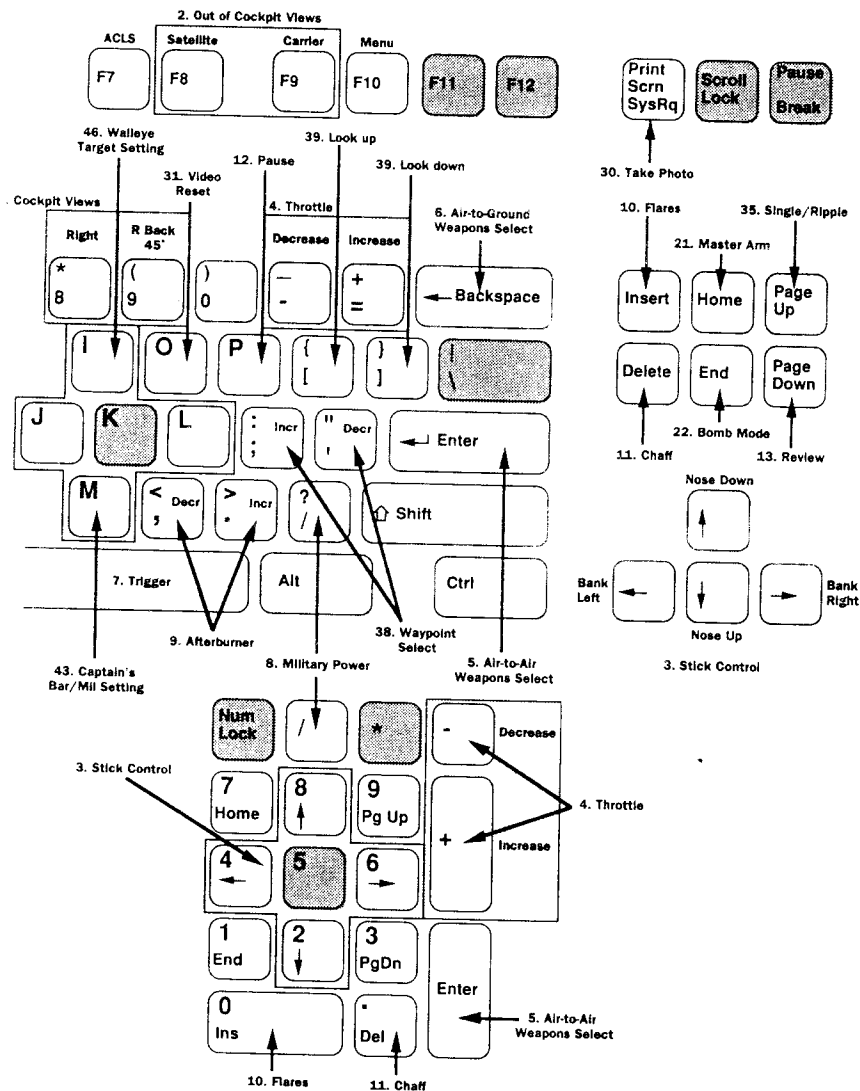
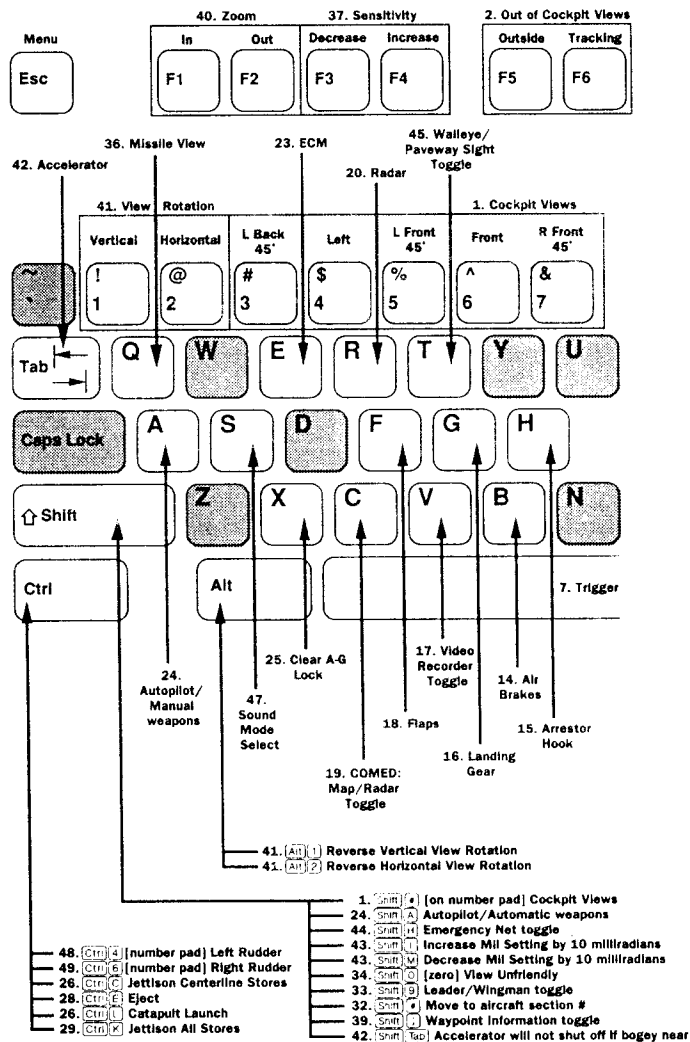

PART XIII: THE KEYBOARD

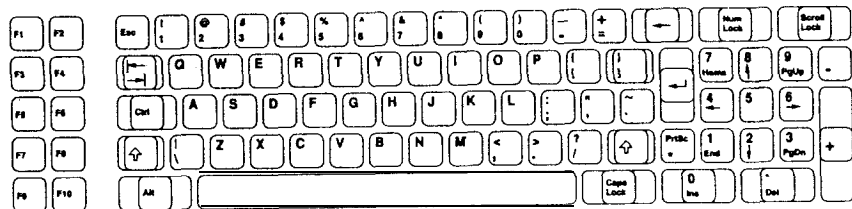

The keyboard is your main access to this game. Even if you are using a mouse or joystick, many commands can only be entered at the keyboard.

The following pages provide a number key to refer to the keyboard layout provided with this game. Take a plane out and play around with this keyboard without trying for scores and accomplishment. We are trying to provide as complete a simulation of Phantom and Intruder flying over Vietnam as we can. We also must somehow give you (one computer game player) the opportunity to accomplish everything that the normal crew of either of these aircraft (two highly trained people) can do. There are a lot of commands to learn here. Take your time and enjoy getting used to the aircraft.

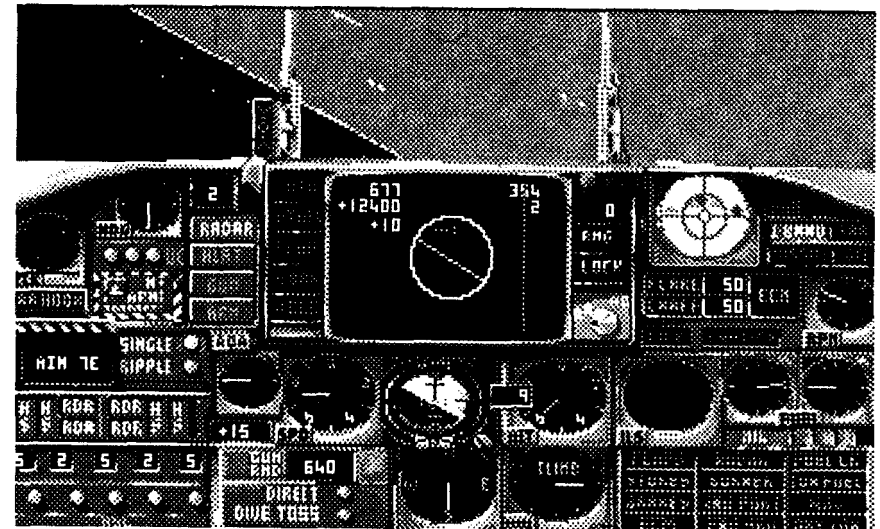

HAVE FUN!

KEY COMMAND DESCRIPTIONS

1. Cockpit views

Press the following keys to change your view out of the cockpit:

View	Keyboard	Number Pad
Left back 45'	[3]	[Shift][1]
Left	[4]	[Shift][4]
Left front 45'	[5]	[Shift][7]
Front	[6]	[Shift][8]
Right front 45'	[7]	[Shift][9]
Right	[8]	[Shift][6]
Right back 45'	[9]	[Shift][3]

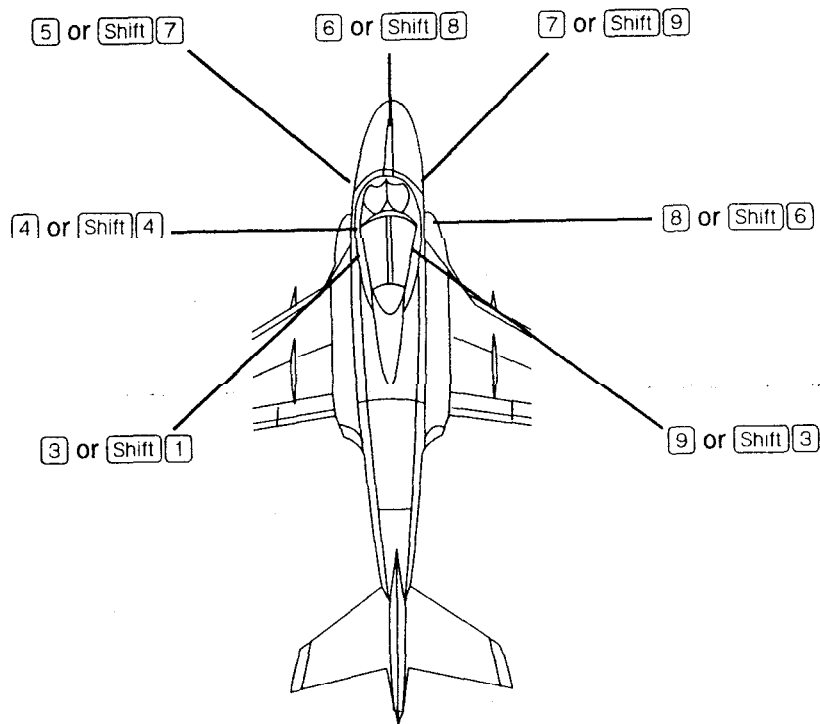

2. Out of cockpit views and special commands

Most of the following keys provide you with views of the aircraft from outside the cockpit. Use these to see your aircraft's position relative to the surrounding geography and to other aircraft.

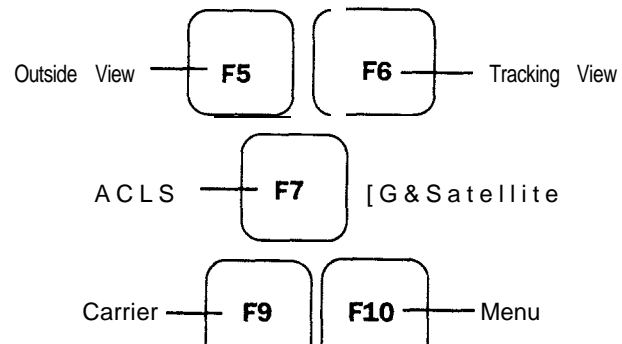

- Outside view** View of the piloted aircraft from a tracking aircraft. The view rotation keys ([1] and [2] on the keyboard) and zoom keys ([F1] and [F2]) are available.
- Tracking view** View of the piloted aircraft from the rear. The view rotation and zoom keys are available.
- ACLS** Automatic Carrier Landing System. This special command toggle turns on the ACLS instruments (see page 140).
- Satellite** Looking down (from satellite) at the piloted aircraft.
- Carrier** View of the home carrier. View rotation keys are available.
- Menu** This special command brings up the menus described earlier and pauses the game until you are done with the menus.

3. Stick control

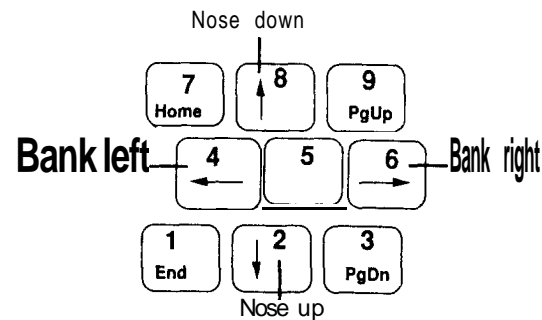

See pages 28-29 for more information on flying with the Stick.

4. **Throttle** Press **[+]** to increase engine throttle which is normally reflected by an increase in RPM and airspeed. Press **[-]** to decrease throttle and RPM. If your keyboard has more than one **[+]** or **[-]** key, you can use either one.
5. **Air-to-air** Press **[Enter]** once to activate the air-to-air weapons select mode (if not already present). Press **[Enter]** again to cycle through the different missile and gun formats. This is not available on the Intruder. This key does not actually toggle between air-to-air weapons on the F-4; instead, it toggles between weapon stations. This is why you may have to hit this key more than once to go from another weapon to the Sparrow AIM 7. If the weapon selector starts on Heat, for instance, it first cycles past the two stations that could carry Sidewinders, then checks the guns, and then looks to the Sparrows. The Sparrow does not count as a normal store on the plane because it has its own dedicated stations; other ordnance cannot be loaded on these stations.
6. **Air-to-ground** Press **[Backspace]** once to activate the air-to-ground weapons select mode (if not already present). Press **[Backspace]** again to cycle through the different missile, bomb and gun formats.
7. **Trigger** Press the **[Spacebar]** to fire all weapons or release bombs.
6. **Military power** The **[I]** key kicks your plane up to military power (100% RPM). It also turns off the afterburner on the F-4 Phantom.
9. **Afterburner** Four stages of afterburner power are available on the F-4, for times when you need to "put the pedal to the metal." Press **[>]** to increase the afterburner stage or **[<]** to decrease it. Note that the afterburner is not available on the Intruder.
10. **Flares** Press **[Ins]** to release flares when heat-seeking missiles are being fired at you by enemy SAM sites or MiGs.
11. **Chaff** Press **[Del]** to dispense chaff and avert *radar-guided* missiles fired at you by enemy SAM sites or MiGs.
12. **Pause** Press **[P]** to pause the simulation. Press it a second time to continue. All view keys in and outside the cockpit are available when the game is paused.
13. **Review** Press **[PgDn]** to toggle through the messages received by your aircraft.
14. **Air brakes** Press **[B]** to activate the air brakes and slow your aircraft down while it's in the air. Press **[B]** a second time to release the air brakes.
15. **Hook** Press **H** to activate the hook on landing. Without the hook down, your plane cannot catch the arrestor wire.
16. **Landing gear** Press **[G]** to raise and lower the landing gear.

17. **Video recorder** Toggle **[V]** to turn the video recorder on and off. You can take a "videotape" of whatever is happening when you press the key until you press it again. When using this feature, the VIDEO light in the cockpit is on until you run out of tape or turn the video recorder off.
18. **Flaps** Press **[F]** to activate wing flaps for speed control. Press **[F]** a second time to deactivate wing flaps. Flaps give extra lift and so are used in landing to allow a slower approach speed. Without flaps, the aircraft would be dangerously close to stall speed when approaching a landing.
19. **COMED** COMED is the Combined Map/Electronic Display. Press **[C]** to toggle between a map detailing the mission landscape and the default radar mode.
20. **Radar** Press **[R]** to turn your radar display off to avoid detection by enemy planes. Press **[R]** a second time to turn the radar display back on.
21. **Master arm** Press **[Home]** to arm each missile and weapon for firing. Any time you go to autopilot, you must press **[Home]** again to arm weapons when you take control again. If you are using a Tandy 1000, the **[7]** on the number pad is the equivalent of **[Home]**.
22. **Bomb mode** Press **[End]** to toggle between the DIANE, Direct and Dive Toss bomb dropping modes.
23. **ECM** Press **[E]** to turn on the ECM (Electronic Countermeasures) pod (if you're carrying one) as a defense against *radar-guided* SAMs. Press **[E]** a second time to turn it off.
24. **Autopilot** Press **[A]** to toggle the autopilot on and off. If you turn on the autopilot during a dogfight, it will track the MiGs for you automatically but not shoot. Real autopilots do not do this, but this is a convenience for the player who wants to participate in a dogfight or bombing run without flying the plane. If there are no MiGs present, the autopilot will fly your aircraft to the target for the current mission. This means it will:
 Follow waypoints.
 Track enemy aircraft without shooting at them.
- However, the autopilot will not release weapons normally. You must press **[Shift][A]** to allow the autopilot to actually fight the plane. Under this option, you are essentially a bystander. The plane automatically performs actions such as dropping bombs at the waypoints and attacking MiGs and radar sites if assigned to do so (pages 62-63 and 69 describe how to set orders for aircraft sections).

25. **Clear A-G lock** If you make an unsuccessful attempt at locking on to a target during an air-to-ground mission, press **[X]** to clear the lock and try again.
26. **Cat launch** Press **[Ctrl][L]** to launch your plane from the carrier catapult.
27. **Jettison centerline stores** Press **[Ctrl][C]** to jettison the centerline stores if you need to get rid of excess weight to give you added maneuverability or acceleration. See also **Jettison all stores** below.
28. **Eject** When all else fails, press **[Ctrl][E]** to eject from your aircraft. However, ejecting is not necessarily the safest or the smartest option in a given situation. Invoke it only as a last resort. If you eject for no reason, your pilot is automatically court-martialed. Ejecting over enemy terrain gets you captured. You can simply die during ejection.
29. **Jettison all stores** Press **[Ctrl][K]** to jettison everything except your *missiles*. This will give you increased maneuverability and acceleration in an emergency. See also **Jettison centerline stores** above.
30. **Take photo** Use **[PrtSc]** to take snapshots of whatever is on the screen at any time. These can be reviewed later during Debriefing.
31. **Video reset** Use **[0]** (the letter "O," not zero) to reset the gun camera to make videotapes of your air combats.
32. **Move between sections** Some missions can have up to four American sections of aircraft with up to two aircraft in each section. Use the following key commands to move between the sections:
- | Section | Command Key (from keyboard) |
|---------|-----------------------------|
| 1 | [Shift][1] |
| 2 | [Shift][2] |
| 3 | [Shift][3] |
| 4 | [Shift][4] |
33. **Leader/wingman** Just as you can move between sections in a mission, you can also toggle between the leader and the wingman in your section. Press **[Shift][9]** to toggle between them.
34. **Unfriendly** Press **[Shift][0]** (zero) to toggle between the piloted aircraft and its current unfriendly (if it has one). A Phantom on MiGCap is allocated a MiG to engage, and an A-6 on Wild Weasel duty is allocated a SAM site to destroy. You can view these unfriendlies by using this key.
35. **Single/ripple** Press **[PgUp]** to toggle between the two bomb release modes. **Single** releases one bomb per trigger press. **Ripple** releases one bomb every second until all bombs on the station are released, allowing you to lay a line of bombs on a long target.

36. **Missile view** Press **[Q]** to toggle between missile view and piloted aircraft view. This lets you follow the missile down to the target. If the missile hits the ground, it explodes.
37. **Sensitivity** Press **[F4]** to **increase** and **[F3]** to **decrease** the aircraft's sensitivity to banking, climbing or diving, on a scale of 0 to 3. You may want to learn making bombing runs at a sensitivity level of 1 and then progress to a level of 3 in aggressive dogfight battles.
38. **Waypoint select** On any outside view (**[F5]**, **[F6]**, **[F8]**), press **[;]** to increase the waypoint number and **[,]** to decrease it. **[Shift][;]** is used to toggle between the distances and bearings in the outside views to three locations.
- Carrier** gives you the relative bearing and range to your carrier. The **[;]** cannot be used to advance or set back the waypoint if this is the location showing.
- Buddy** gives you the relative bearing and range to your wingman. The **[;]** cannot be used to advance or set back the waypoint if this is the location showing.
- Navigate** is the default setting. The **[;]** can only be used if this is the readout. It gives you the relative bearing and range to your next waypoint. It is possible that another message, such as Attack or Land, will appear in this space if that is the next waypoint for the aircraft. See the next paragraph.
- Press **[>]** to advance your current waypoint as shown on the outside views, effectively changing it for the plane. The readout does not give you the exact waypoint order. Any combat waypoint order (such as "Drop Paveway," "Fire Walleye," "Drop Bombs" and "Circle") is shown as "Attack." Any other order is shown as "Navigate." These readings show up as ATTACK, NAV and LAND on the DIANE. (The F-4 has no such reading on its radar screen.)
- Press **[<]** to set back the current waypoint. If your plane missed the target, you can use this key to bring back the Attack waypoint so the plane will go back to the right point on autopilot and you can try again.
39. **Look up/down** Press **[↑]** to look up above the usual cockpit view (a "head up" view) and **[↓]** to look down at the cockpit (a "head down" view). This latter key can be used in the Phantom again to look even further down to see more instruments. The A-6 only has a "head up" view.
40. **Zoom** Press **[F1]** to zoom in closer to the aircraft and **[F2]** to zoom out. Use in conjunction with the outside view **[F5]** and the tracking view **[F6]**. This key also works with the carrier view **[F9]** and the missile view **[Q]**.

- 41. View rotation** In any noncockpit view, press [1] on the keyboard to shift through different vertical views of your aircraft. Each key-press changes the orientation along a circle surrounding the aircraft, starting from the rear up and forward and then from the front down and back. Press [2] on the keyboard to cycle through views moving horizontally around the aircraft. Using [Alt] with either of these keys rotates the point of view in the other direction. This key also works with the carrier view [F9] and the missile view [Q].
- 42. Accelerator** Press [Tab] to speed up the action during long flights over the sea. This speeds time up for everybody in the simulation (friendly or otherwise) and moves you toward the target at increased speed. The accelerator is automatically deactivated when you approach the target or when you are approached by a MIG or SAM. If you don't want automatic deactivation, use [Shift][Tab]. You can also toggle the accelerator off by pressing [Tab] a second time.
- 43. Captain's bars** Press [M] to move the "Captain's bars" onto the target (see Walleye delivery method).
Mil Setting. Also, the [I] and [M] keys can be used to alter the Mil setting of the sight on the HUD (see pg. 128). This measurement is in milliradians, hence the name. [Shift][I] and [Shift][M] increment and decrement the Mil setting by 10 milliradians.
- 44. Emergency net** Toggling [Shift][H] activates and deactivates the emergency net if you are afraid you cannot land your plane normally.
- 45. Walleye/Paveway sight toggle** Use [T] to toggle between sight modes when using the Walleye or Paveway guided weapons.
- 46. Walleye target setting** Use [J], [I], [L] and [M] to move the Walleye sight around on the screen.
- 47. Sound** Press [S] to toggle the sound between the options found on the **CONTROL menu**. Once you have picked the type of sound you want from the **FILE menu**, you can use this key during the game to toggle between "All Sound On," "Engines Off" and "All Sound Off."
- 40. Rudder left** Press [Ctrl][4] to make a flat turn to the left just using the rudder controls without banking.
- 49. Rudder right** Press [Ctrl][6] to make a flat turn to the right just using the rudder controls without banking.

PART XIV: EXAMPLE OF PLAY AND FURTHER READING

ASSEMBLY BUILDING IN HANOI LEVELED!

Rules Of Engagement Violated!

The following narrative is from Mike "Moondawg" Weksler, who describes his mission to duplicate Jake Grafton's attempt to bomb the National Assembly Building in downtown Hanoi. One note: "No. 19" is the callsign of Spectrum HoloByte's Development Services Manager, Marisa Ong-hence the references to a supposed Vietnam-era bomber pilot as "she."

On 19 June, 02:00, I go to ready room for mission planning. Make sure to hit **F10** and select Captain, the proper control device, and other applicable options. After pressing **Esc**, I enter my callsign as "Devil, 50" on the duty roster and proceed to target selection.

I select the power station in Hanoi, with the secondary target being the SAM site 180 south of Hanoi. I review the photo of the power station and hand the coordinates to my Bombardier/Navigator (B/N), Virgil "Tiger" Cole, for later programming into the navigation computer.

I save this, exit out and when everyone has left, go back to get info on the real objective of this mission: the Assembly Building in downtown Hanoi. "Too many lives were being sacrificed for worthless targets such as 'suspected truck parks,'" I think as I reflect on "Morg." (Morgan McPherson flew with me on a "truck park" mission. We had flown together for two years. He was my friend. A stray bullet killed him on that run.)

I note the coordinates for the Assembly Building and load up my original target file to review the information. Target intelligence provides a map and photos of the power station, but no photos of the SAM site-just a spot on the map.

We review general intelligence. This shows that the MiG activity in the vicinity of the primary target is high and ground activity low.

But after we bomb the primary target we're going to violate the Rules of Engagement and take out that Assembly Building in downtown Hanoi. From the intelligence I can gather for the Hanoi area, I can see that all enemy activity would be high. I give Tiger the target info, we grab some coffee and then go through the routine of donning our flight gear,

On the night deck, Tiger punches in the waypoints for the power plant strike, but then adds the waypoint to the Assembly Building with the waypoint editor.

At the first waypoint, he changes the altitude to 500 ft and sets the action to ripple bombs to make it look like we're gonna dump it all on the primary target. The second waypoint is also changed to 500 ft and ripple bombs. If we have to, we'll page to the other A-6 and our bird will fly to the Assembly Building on its own. He then tabs the Next Section icon and is pleased to see that we are the only section on this mission. This means we can leave the primary target area relatively unnoticed and fly to Hanoi.

I can see No. 19, my wingman for this mission and her B/N, Greve, going over last minute details on their bird. I approach the Ordies and proceed to go over

the ordnance with the Chief. I offer to take him up on a joyride later if he agrees to issue us some of the 2000 pounders, instead of the standard strike load of ten MK82s, one Paveway, and two Walleyes.

He agrees and we load up with five MK84s to penetrate the heavy duty concrete of the Assembly Building. This leaves no room for the ALQ radar jamming pod so we'll be flying very low. Tiger makes some remark about pruning tree-tops, but I'm too nervous to quip back.

It's now 0215. As we ready for the flight, I choose the "A" icon to insure we're launching at 0230 and we're set up for a bombing run.

I run through the preflight checklist (double checking every waypoint and action) and Tiger checks his equipment out.

I salute the cat officer and with a war whoop hit **Ctrl****L**. Soon I'm flying at 8 K/AS above my stall speed. No wind tonight and the carrier is steaming at 20 KTS-barely enough to get us up. "At least the weather is calm," I think.

I raise the gear and flaps. Soon, with the aid of **Tab** to accelerate the time rate, we are at 325 K/AS at 25,000 feet. "We're gonna have to go nice and slow on ingress to save fuel," I say to Tiger. He clicks his mike in response. I page to No. 19 in Devil 502 just as she is launching.

I can see my jet climbing out of her cockpit. "No transcendental meditation would let me do this," I murmur. Greve was having problems with his NAV and targeting computer. DIANE was on the blink. and he would have to bomb direct. I page back to my jet.

At 74 NMs from Downtown I start descent and go through the master arm checklist. At 500' I level off and call feet wet. By staying low and flying "up the river," we seem to have avoided the enemy. They know we're coming and my warning lights are all lit up, but they can't get a lock on us as we blend into the ground return. The terrain is so flat that we frequently fly below 200'. No tracers, no nothing. Can't hit **Tab** because we'd hit the ground. We approach the target. I let Devil 502 go in first because she can strike lower than us because we have MK84s. I climb up to 2000' and Tiger says that the pickle is hot. I watch Devil 502 take out the target. "Better go in and drop one off for good measure," Tiger says. I climb higher, then dive at the target. The attack indicator lights up and I watch the little block in my VDT move closer to the center. It starts to fill in and as I fly closer to the target, the horizontal release indicator comes on. When it hits the bottom of the screen, I release and place the 2000 pounder right in the boiler. We feel the turbulence of the blast as we destroy what's left of the target.

Tracers light up the sky, but I fly over them like a high jumper just clearing the bar. I can't get below 2000' until we are clear of the target area. We still have four 2000 pounders left for the Assembly Building. "We'd better get down to business," Tiger murmurs.

I page to Devil 502, hit the **;** until the waypoint reads 'Land' and invoke her ILS with the **F7**. Then I switch back to my lead position.

It comes as no surprise when Devil 502 radios to me with a system malfunction. Something is wrong with her NAV computer and she is going to bug out. I radio back that I am enroute to the SAM site south of the Hanoi but have to change course to avoid some AAA. We are now alone.

So far, no enemy aircraft on RWR. All clear on ingress to Hanoi. As we approach the city, I climb up to 4000' and Tiger pinpoints the Assembly Building. He says, "Your pickle is hot," and I dive for the target. It looked just like the Intelligence I had acquired. "This one is for you, Morg!" I think as I squeeze the release button. A// of the MK84s hit their target. We feel the repercussions from the explosions as distinct thuds violently shake our aircraft.

I realize I flew too low. The damage warnings light up the B/N panel. Either our own bomb explosions got us or the AAA has us locked. I can see tracers, so I hug the ground so close I'm afraid I'll snag a clothesline. Circling around to make sure the building is destroyed, I see that I've unfortunately taken out the next-door building too. I only wanted to damage the leadership. Hope no civilians were in that next building.

I hit the [] to start egress. When we are clear of enemy fire, we survey the damage. The COMED is useless; the radar must have taken the damage. However, the NAV computer is still functioning enough to guide our autopilot back to the landing waypoint on the Shiloh.

I throttle to full Mil power, hugging the ground and managing to somehow extend on the bogies scrambling to intercept us. Tiger breaks the silence with a "Fancy shootin' pardner," as we head for the coast; we know we've disturbed a wasp's nest; now they are going to buzz around our faces, ready to sting.

I page to Devil 502 as she calls feet wet. She must have run into some MiGs or taken a SAM hit or something... Everything is foxtrot Uniform in this bird. The COMED is just black. Somehow, it is still flying. I page back to my own A-6.

"What are you doing popping in and out of here all the time?" Tiger growls. "Don't you know the autopilot makes us climb? I was a sitting duck while you were gone!" He's right. My panel shows a SAM launch. Talk about pucker factor! A second SAM launches before I can dive into the ground return. "Jake, it's closin' fast... Five o'clock!" I dump some chaff and a/most f/y the bird into the ground. I black out as I pull up but am still in control.

When my vision clears the first SAM is gone. Must have hit the ground as we pulled out of the dive. We're now off course at angels 2. The second SAM is still closing. I hit the chaff button and dump as much as I can. Mu/tip/e bogies are still closing. A/most to the coast now. I dump more chaff and jink out of the way of the remaining SAM as it goes off guidance. We can see the SAM go right past the right wing. "Get down!" Tiger ye/s at me.

I skim the trees the rest of the way back to the coast. I b/end in with the ground return and f/y along the river. No further SAM launches. The AAA light is still lit, but I know they can no longer sing/e me out of the ground return.

I call Feet Wet and start my ascent. I know that when I get back I'm going to catch hell for this. Maybe even a court-martial in the Debriefing mode. "Bingo fuel," is a// that Tiger says as he reminds me to throttle back. At angels 2, all I can wish for is the KA-6 to f/y by and give us a fill-up, but I know that it's not f/ying. I hit the autopilot and and sit back, pressing [Tab].

I avoid paging Devil 502 because if it lands while I'm in it, the mission is over. Checking every way out of my own cockpit shows no sign of my wingman. "Must be on final," I think.

The sky is clear and we seem to be the last ones up. I invoke the ILS with the [F7] and line up my need/es. Tiger and I remain silent. The LSO doesn't even, ask me to call the ball. OK, throttle back, flaps, gear and hook down. Need/es lined up, I can see the meatball. I'm too low. Climbing. Now I'm too high. Can't seem to line up. K/AS is 174 and I'm 400'. Need/es high and center, fuel 1000 pounds. I shove the nose forward and hit the deck with a force that we both are sure will push the landing gear struts through the wings! Then we feel the reassuring tug of the number four wire and start to breathe again.

Devil 501, over, out.

FURTHER READING

- ALPHA STRIKE VIETNAM*, Jeffrey L. Levinson, Presidio Press, 1989
- ... *AND KILL MIGS*, revised edition, Lou Drendel, Squadron/Signal Publications, 1984
- THE AVIATION/SPACE DICTIONARY*, 7th edition, Larry Reithmaier, Aero division of TAB Books Inc., 1990
- F-4 *PHANTOM II IN ACTION*, Larry Davis, Squadron/Signal Publications, Carrollton, Texas, 1984
- F-4 *PHANTOM IN DETAIL AND SCALE, VOLS 7 & 12*, Bert Kinzey, Aero division of TAB Books Inc., 1982
- FLIGHT OF THE INTRUDER*, Stephen Coonts, Naval Institute Press, 1986
- THE HUNGRY TIGERS*, Frank O'Brien, Aero division of TAB Books Inc., 1985
- INTRUDER*, Roger Chesneau, Linewrights Ltd., 1986
- THE MCDONNELL F-4 PHANTOM*, Robert F. Dorr, Aero division of TAB Books Inc., 1989
- MODERN A/R COMBAT*, Bill Gunston and Mike Spick, Salamander Books Limited, London, 1983
- MODERN COMBAT AIRCRAFT, INTRUDER VOLUME 26*, Ian Allan Ltd. distributed in U.S.A. by Motorbooks International, 1987
- MODERN COMBAT AIRCRAFT, PHANTOM VOLUME*, Ian Allan Ltd. distributed in U.S.A. by Motorbooks International, 1977
- MODERN COMBAT AIRCRAFT, THUNDERCHIEF VOLUME*, Ian Allan Ltd. distributed in U.S.A. by Motorbooks International, 1981
- MODERN FIGHTING AIRCRAFT*, Volume 4 F-4 Phantom, Richardson and Spick, Salamander Books Limited, London, 1987
- MODERN FIGHTING AIRCRAFT*, Volume 9 MiGs, Bill Sweetman, A Salamander Book published in the U.S.A. by Arco Publishing Inc., New York, 1985
- MODERN SOVIET WEAPONS*, Edited by Ray Bonds, Salamander Books Ltd., 1986
- PAK S/X*, G.I. Basel, Associated Creative Writers, La Mesa, California, 1982
- PHANTOM OVER VIETNAM*, John Trotti, U.S.A. Presidio Press, 1984
- TONKIN GULF YACHT CLUB*, Rene J. Francillon, Naval Institute Press, 1988
- TOP GUN*, George Hall, Presidio Press, 1987
- USN PHANTOMS IN COMBAT*, Lou Drendel, Squadron/Signal Publications, 1988

PART XV: INDEX

A

A - 6 Intruder	
Background and Specifications	151
Bombing	34,41,126
Cockpit and Controls	33,101,103
Cruising Altitude	35
Optional External Fuel Tanks	66
Pilot Personalities	71
Takeoff, Flying, Landing	4,40,141
Types of Missions	39,126
A-A (Air-to-Air Missile)	158
AAA (Anti-Aircraft Artillery)	75,158
AAA Warning Light	104
Abort Mission, FILE menu Selection	20
Accelerator Key	36,178
ACLS (Automatic Carrier Landing System)	104,140,158
ACM (Air Combat Maneuvers)	114,158
AdLib Sound Board	17
See also Sound: Selection	
FILE menu Selection	20
ADI (Attitude Director Indicator)	34,103,158
ADL (Aircraft Datum Line)	158
Afterburner (AB)	158
Keys	174
AGM (Air-to-Ground Missile)	158
AGM-45A	See Shrike
AGM-62	See Walleye
AGM-78	See Standard
AIM (Air Interdiction Missile)	158
AIM-7	47,52
See a/so Sparrow	
AIM-9	48
See also Sidewinder	
Air Brakes Key	174
Air Wing	158
Air Wing Score	96
Air-to-Air	
Selector Key	174
Weapons	122
Air-to-Ground	
Selector Key	174
Weapons	132-136
Aircraft Duties	69
Aircraft Information	68

Aircraft Specifications	142-147
Aircraft Summary Comparisons	147
Aircrew Personnel	70
Airspeed	33,158
Alpha Strike	153,158
Altimeter	34,103,158
Angels	158
AOA (Angle of Attack)	158
Indexer	104,139,158
Indexing to Pitch	139
Indicator	103,159
Area of the Game	60
Arrestor Net	159,178
ASI (Airspeed Indicator)	103,159
Aspect Angle	52
Atoll Missile	75,92,159
Ault Report	154,159
Autopilot	36,37,49,159
Keys	175
Average Score	96,98
Awards	99
FILE menu Selection	20

B

Bad Weather	22
Badges	98
Bandit	159
Bearing	159
Bingo Fuel	159
Blackout	24,159
BN or B/N	159
Bogey	13,159
Bolter	159
Bomb Mode Key	175
Bomb Run	159
Bombardier/Navigator	101,121,159
Bonanni, Pete	2
Briefing Room Board	31
Bull's Eye	60,64

C

CO.	160
CAG (Commander Air Group)	13,159
Calibrate Joysticks	22
"Call Your Needles"	41
Callsigns	31,160

Finding Other Planes'	121	Cosand, Norman	2,91,93
Camera On, FILE menu selection	20	Court-Martial	13,78,161
Campaign		CV and CVA	161
Endsweep	156	D	
Flaming Dart One	149	Debriefing	38,94,161
flaming Dan Two	149	Deflection Shooting	49
Linebacker	13,164	Delete Statistics	95
Linebacker I	155	DIANE	107,127,161
Linebacker II	156	Digitized Sound, FILE menu Selection	20
Rolling Thunder	150	Direct Bombing	107,128
Rolling Thunder V	154	Dive Toss Bombing	107,129
"Captain's Bars"	47	Dixie Station	161
Key	178	DMZ (DeMilitarized Zone)	161
Carrier Landing	50,137	Dogfight	161
By Autopilot	38	"Double Ugly"	51
Carrier, Other	98	Duty Pilot Landings	96,138
Cat (Catapult)	160	Duty Roster	31,161
Catapult Launch Key	176	E	
CBU (Cluster Bomb Unit)	160	ECM (Electronic CounterMeasures)	105,161,175
Ceiling	39,160	Egress	161
CH FlightStick	21	Eject Key	176
Chaff	160	EMIT Light	105
Key	174	Enclosed Reference Card	105
Charlie	160	End Mission	20,38
China	60	Enemy	161
Clag	40,159	Activity, OPTIONS menu Selection	24
Climb Rate	160	Encounters	75
Clock Code	121	Energy	52,112
Six O'Clock	35,166	EW (Electronic Warning)	161
Twelve O'Clock	45	Example of Play	179
COBB	42,160	Exit, FILE menu Selection	20
Cockpit	160	F	
Cockpit Views Keys	172	F-4 Phantom	
Collisions, OPTIONS menu Selection	23	Autopilot and Waypoints	110
Colonel Toon	154,160	Background and Specifications	144
COMED (Combined Map/Electronic Display)	33,36,160	Cockpit and Controls	44-46,102,103,105,107,108,122
Key	175	G-Force Limit	110
Reading the	105	Going into Combat	46
Comms Connection Details Screen	27	Optional External Fuel Tanks	66
Compass	33,34,103,160	Pilot Personalities	73
Contributors	3	Radar	108,109
Controlling Your Aircraft	28,45	Static	109
Coonts, Stephen	2,4,126		
Corridor Scene	31		

Using the Walleye	133	H	
Weapon Station Capacity	67	Haiphong	60,162
Feet Dry	40,161	Handley, Phil	2,51,54
Feet Wet	161	Hanoi	60,91,163
FFAR See Zuni Rockets: definition		Hanoi Hilton	163
Finding the Carrier	139	Heading	60,163
First Flight	35,45	Ho Chi Minh Trail	155
Flaps	161,175	Home Key for Tandy 1000	36
Flares	162,174	Hook Lowering Key	174
Flight Instruments	101	How to Fly Jets	111
Flight Performance Envelope	112	HUD (Head Up Display)	102,128,163
Flight Suit	4	HUD Dot	102
Dabbed With Paint	98	I	
FOD (Foreign Object Damage)	52,162	I-Band Warning Light	104
Friendly	13,162	IAS (Indicated Airspeed)	
Fuel		See Airspeed: definition	
Gauges	103	IFF (Identification Friend or Foe)	
Management	120		110,163
Minimum for Landing	120	ILS (Instrument Landing System)	163
OPTIONS menu Selection	25	Index	185
Further Reading	184	Indexing Preferences to Rank	
G		OPTIONS menu Selection	25
G-Force	111	Ingress	40,163
Gauge	110	Input Devices	17
Game		CONTROL menu Selection	21
Map Enclosed With This	60	Usable with Menus	19
Object Of and Success In	13,97-99	Installation of Game	15
Pausing the	29,33,174	Instructions, Stepby-Step	17
GCI or GIC (Ground Intercept Control)		Introduction	12
	162	Iron Bombs	135,136
GCI Warning Light	104	Iron Hand	152
Gear, Landing	162	Iron Triangle, the	163
Key	174	J	
General Intelligence	59	Jamming	163
Getting Started	14	Jettison All Stores Key	176
GIB (Guy In Back)	53,162	Jettison Centerline Stores Key	176
"Go Dirty"	41,162	Jink	163
Ground Crashes, OPTIONS menu		Joystick	28
Selection	24	See a/so Input Devices	
Ground Fire	75,162	CONTROL menu Selection	21
G's	111,162	JP and JP-5	163
GSD (Glide Slope Deviation)	162	K	
Gulf of Tonkin	149,162	Key Command Descriptions	172
Gun	125	Keyboard	28,170

See a/so Input Devices		Messages	
CONTROL menu Selection	21	How to Interpret	121
Keyboard Layout	168	MIG	53,164
Khe Sanh	154	MIG Day	75
KIAS	163	MiG-17	145,147,151
Knot (KTS)	163	MiG-19	146,147
Korat AFB	91,163	MiG-21	147
L		MiGCAP	13,153
Laos	60	Mil (Milliradian)	164
Large Scale, CONTROL menu Selection	22	Mil (Military Power)	164
LAU-3A See ZUNI Rockets		Key	174
Leader/Wingman Transfer Key	176	Mil Determination Tables	128,130
Leading a Target		MILS Depression Reading	105
See Deflection Shooting		Missile View Key	177
LGB (Laser Guided Bomb)	164	Missile Warning Light	104
Limited Arms	125	Mission	13,164
OPTIONS menu Selection	23	BARCAP	45,159
Limited Chaff & flares, OPTIONS menu		Bombing	13
Selection	23	CAP	160
Lock Light	47	Definition of	77
Lock-On	48,164	Escort	161
Look Up/Down Keys	177	Hunter Killer	91
LSO (Landing Signal Officer)	164	Iron Hand	163
M		MiGCAP	164
M61A1 Vulcan	49,164	Planning Process	56
See a/so Gun		RESCAP	165
Mach	164	Saving the CAG Planned	57
Manual		Seeing Detailed Results of	38
About This	14	TARCAP	166
Conventions	14	Time Selection	70
Manual Targeting	164	Mouse	28
Map, Using the Enclosed	64	See a/so Input Devices	
Master Arm Switch	47,107,164,175	CONTROL menu Selection	21
McGinn, John	2,39,42	Move Between Sections Keys	176
Meatball	138,141,164	Multiple Weapon Selection Panel	46
Medals	99	N	
Menus		Nautical Mile (NM)	
ABOUT menu	19	See Knot (KTS): definition	
Availability of	19	Negative G's	111,113,136
CONTROL menu	17,21	Normal Engines, OPTIONS menu	
FILE menu	17,20	Selection	23
LEVEL menu	21	Nuggets	165
OPTIONS menu	23	O	
Pull-down	19	"On your six"	165
		Operation	13,165

Definition of	77	Redout	24,136,165
Information Icons	32	Return, FILE menu Selection	20
Morning Song	13	Review Messages Key	174
Selection	31	RF and rf	165
Statistics	95	RF-4C	52
Operation Homecoming	156	RIO (Radar Intercept Officer)	53,166
Operations	79-90	Ripple Bornb Release	107,136
OPTIONS menu	78,110,125,136	River Rat	166
Ordies	39,165	Rockeye	166
Ordnance	96,165	Rookie	166
Out of Cockpit Views Keys	173	RPM (Revolutions Per Minute)	166
Outside View	121	Gauge	33
Over the Beach	165	Rudder Turns	29,178
P		Rules of Engagement	13,77,150,166
P.O.W.	165	CONTROL menu Selection	22
Paris Peace Talks	155	S	
Paveway	134	Saigon	166
PC Tones, FILE menu Selection	20	SAM (Surface-to-Air Missile)	75,166
Personnel	2	SAM Day	75
Personnel Descriptions	70	SAM Warning Light	104
"Phantom Man"	165	Screen Messages, Purposes Of	121
Phantom Pilot Brief	44	Section	166
Photos		Sensitivity Indicator	104,177
Reviewing	38	Shrike Missile	132,166
Saving to Disk	97	Sidewinder	48,124,153,166
Pilot Ratings	71	Sierra Hotel	38,98,166
Pitch	165	FILE menu Selection	20
Positive G's	111,159	Single Bomb Release	136
Practice Landings	140	Single/Ripple Release Key	176
Preflight Planning	39	Slide Show, FILE menu Selection	20
Pulling G's	112	Snapshot	97,176
Pull Up Light	165	Sound	
R		Selection	
Radar		AdLib	16
Detection	46	Digitized	17
How to Read Screen	109	PC Tones	17
Key	175	Options	17,22,178
Lock	110	Sparrow	47,123,153,166
Mode Changes	33	Special Commands Keys	173
Radar Warning Receiver (RWR)		Stall	112,166
Explanation of Readings	104	Standard Missile	132
Radio, Use Of	121	Stick	28,166
Recalibrate Mouse or Joystick		Control Keys	173
CONTROL menu Selection	21	Stick&T&Rudder, CONTROL menu	
Red Crown	45,46,165	Selection	21

Stick&Throttle, CONTROL menu		V	
Selection	21	VGA Version	16
Stores	65,166	Video	
Success Rating	95	Recorder Key	175
"Sunday Punchers"	42,151	Replay	97
Super Engines	166	Replay, FILE menu Selection	20
OPTIONS menu Selection	23	Reset Key	176
T		Reviewing Tape	38
Tachometer	103	Vietnam Naval Air Losses	156
Take Photo, FILE menu Selection	20	View Rotation Keys	178
Takeoff Procedures	35,45	Viewpoints	
Target		Shifting Around Cockpit	34
Height and Speed for Pickling	126	WI (Vertical Velocity Indicator)	103
Target Aspect Angle	40	On Radar Screen	109
Target Information	39	W	
Target Intelligence	58	Walleye Missile	14,32,133,158
Targets		How To Fire	37,133
Bandits	79	Target Setting Keys	178
Haiphong Docks	89	Walleye/Paveway Sight Key	178
Hanoi Power Plant	13,86,180	Waypoints	61,62
Paul Doumer Bridge	88	Actions	63
Phuc Nhac Airfield	83	Checking	38
Phuc Yen Airfield	87	Editing	60
SAM Site	90	Selection Keys	177
Thai Nguyen Steel Plant	91	Weapons	
Thanh Hoa		Selection Description Panel	107
Ammunition Dumps	84	Stations	46
Bridge	81	Y	
Torpedo Boats	79,82	Y-cable	21
Yen Bai Railroad Bridge	13,80	Yankee Station	98
Targets, Easy, Medium, and Hard		Yen Bai	60
OPTIONS menu Selection	24	Z	
Tet Offensive	154	Zoom Keys	177
Than Hoa	60	Zuni Rockets	135,161
Threat Indicator	46		
Throttle Keys	174		
Top Gun School	154		
Trap	120		
Trigger Key	174		
Turns	28		
U			
U.S. Navy Vessels	149-151,153,156		
Unfriendly Viewpoint Key	176		

A FINAL WORD

The Vietnam War tore America apart. It was an era that pitted young against old, liberal against conservative, poor against rich, and black against white. Over 58,000 Americans died. Another 153,000 were wounded. The Vietnamese lost even more. Today, there are many opinions and viewpoints about the U.S. involvement in Southeast Asia. Flight of the Intruder is intended to give you the Naval Aviator's point of view.

The Navy lost 377 pilots in Vietnam. For many aviators, the most upsetting part of the war was not the loss of life but the loss of life without purpose. Many pilots were killed attempting to bomb meaningless targets. The Vietnam War became a war of statistics. Sortie, mission, and target counts became more important than the lives of the people who put their lives on the line every day.

This game is not intended to glorify the war but is designed to give you a better understanding of the sacrifices we asked our warriors to make. We at Spectrum HoloByte are attempting to give you a very realistic: simulation of the era. We want you to appreciate the effects of the rules which we made our aviators operate under and to appreciate the effectiveness of the North Vietnamese defenses.

When you play the game, play it as if you were in a real A-6 or F-4 in Vietnam. When you are hit by a missile or shot out of the sky in the game, understand that if you were a aviator in Vietnam, you **would** have died. The men who flew in Vietnam did not have the ability to reset the game or turn off the computer. They did not have the ability to simply turn off the Rules of Engagement.

War, especially the Vietnam War, is not about machines and technology. It's about people and politics. It's about lives and deaths. War is not a game. It should never be reduced again to a collection of statistics. We should never take decision of war lightly and never ask our youth to sacrifice their lives without cause. Perhaps in the future we can live in a world in which we are dedicated to building rather than destroying.

This game is dedicated to all those people who sacrificed their lives and those who lost their dreams and loved ones in Vietnam.



G. Louie
CEO/Chairman
Sphere, Inc.

Spectrum HoloByte™ Ninety-Day Limited Warranty

To the original purchaser only, Spectrum HoloByte warrants the magnetic diskette on which this software product is recorded to be free from defects in materials and faulty workmanship under normal use for a period of ninety days from the date of purchase. If during this ninety-day period the diskette should become defective, it may be returned to Spectrum HoloByte for a replacement without charge, provided you have previously sent in your Warranty Registration Card to Spectrum HoloByte or send proof of purchase of the program.

Your sole and exclusive remedy in the event of a defect is expressly limited to replacement of the diskette as provided above. If failure of a diskette has resulted from accident, abuse or neglect, Spectrum HoloByte shall have no responsibility to replace the diskette under terms of this limited warranty.

If the diskette should fail after the original ninety-day limited warranty period has expired, you may return the diskette to Spectrum HoloByte at the address noted below, accompanied by a check or money order for the applicable replacement fee as outlined on the Warranty Registration Card, a brief statement describing the defect and your return address. Spectrum HoloByte will replace the diskette provided that you have previously returned your Warranty Registration Card to Spectrum HoloByte, and the diskette retains the original product label.

ANY IMPLIED WARRANTIES RELATING TO THE DISKETTE, INCLUDING ANY IMPLIED WARRANTIES OF MERCHANTABILITY AND FITNESS FOR A PARTICULAR PURPOSE, ARE LIMITED TO A PERIOD OF NINETY DAYS FROM DATE OF PURCHASE. PUBLISHER SHALL NOT BE LIABLE FOR INDIRECT, SPECIAL, OR CONSEQUENTIAL DAMAGES RESULTING FROM THE USE OF THIS PRODUCT. SOME STATES DO NOT ALLOW THE EXCLUSION OR LIMITATION OF INCIDENTAL OR CONSEQUENTIAL DAMAGES, SO THE ABOVE LIMITATIONS MIGHT NOT APPLY TO YOU. THIS WARRANTY GIVES YOU SPECIFIC LEGAL RIGHTS, AND YOU MAY ALSO HAVE OTHER RIGHTS WHICH VARY FROM STATE TO STATE.

Spectrum HoloByte™

Division of Sphere, Inc.
2061 Challenger Drive
Alameda, CA 94501
(415)522-3584

Keyboard Command Layout

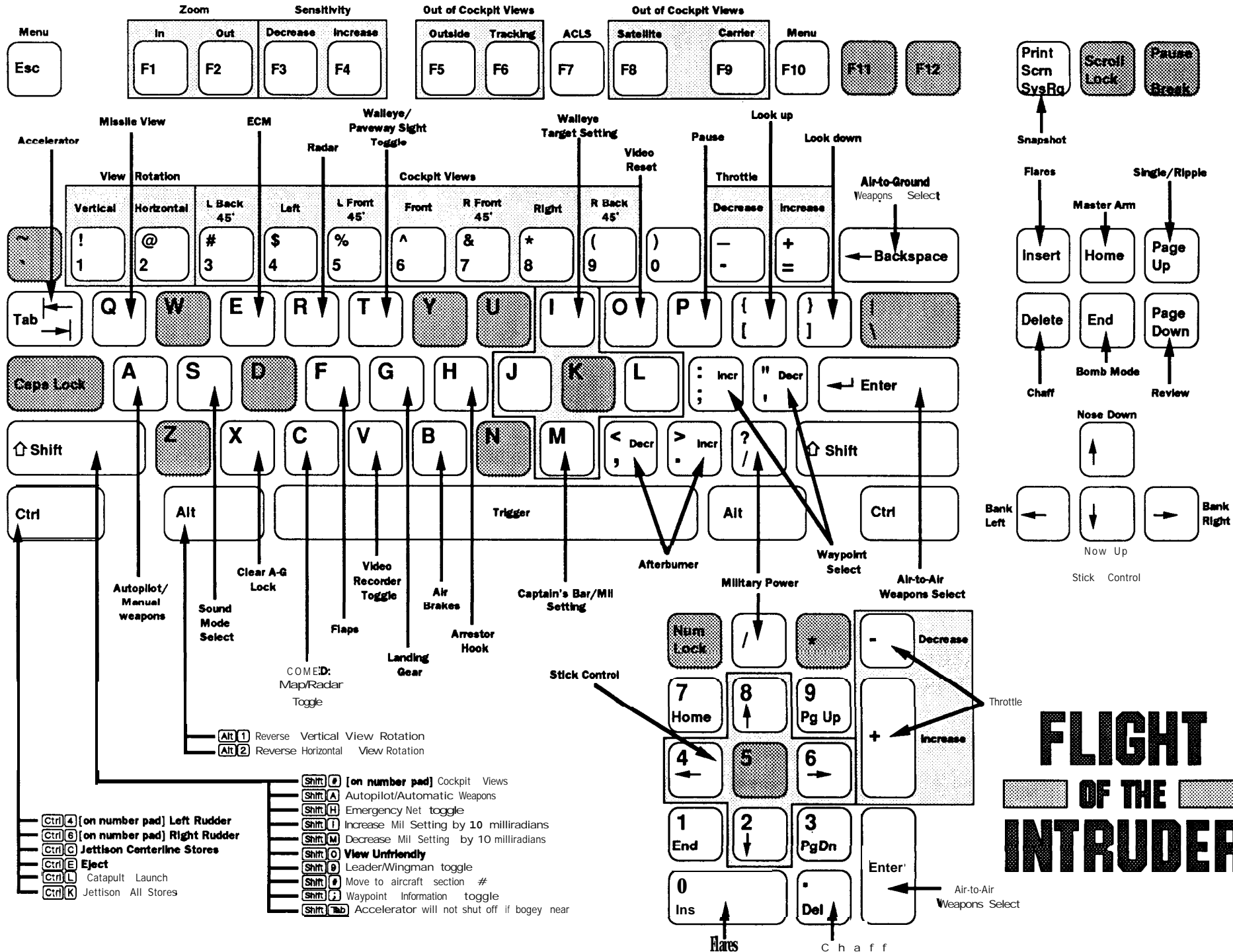

F-4 Phantom Cockpit (Front Panel)

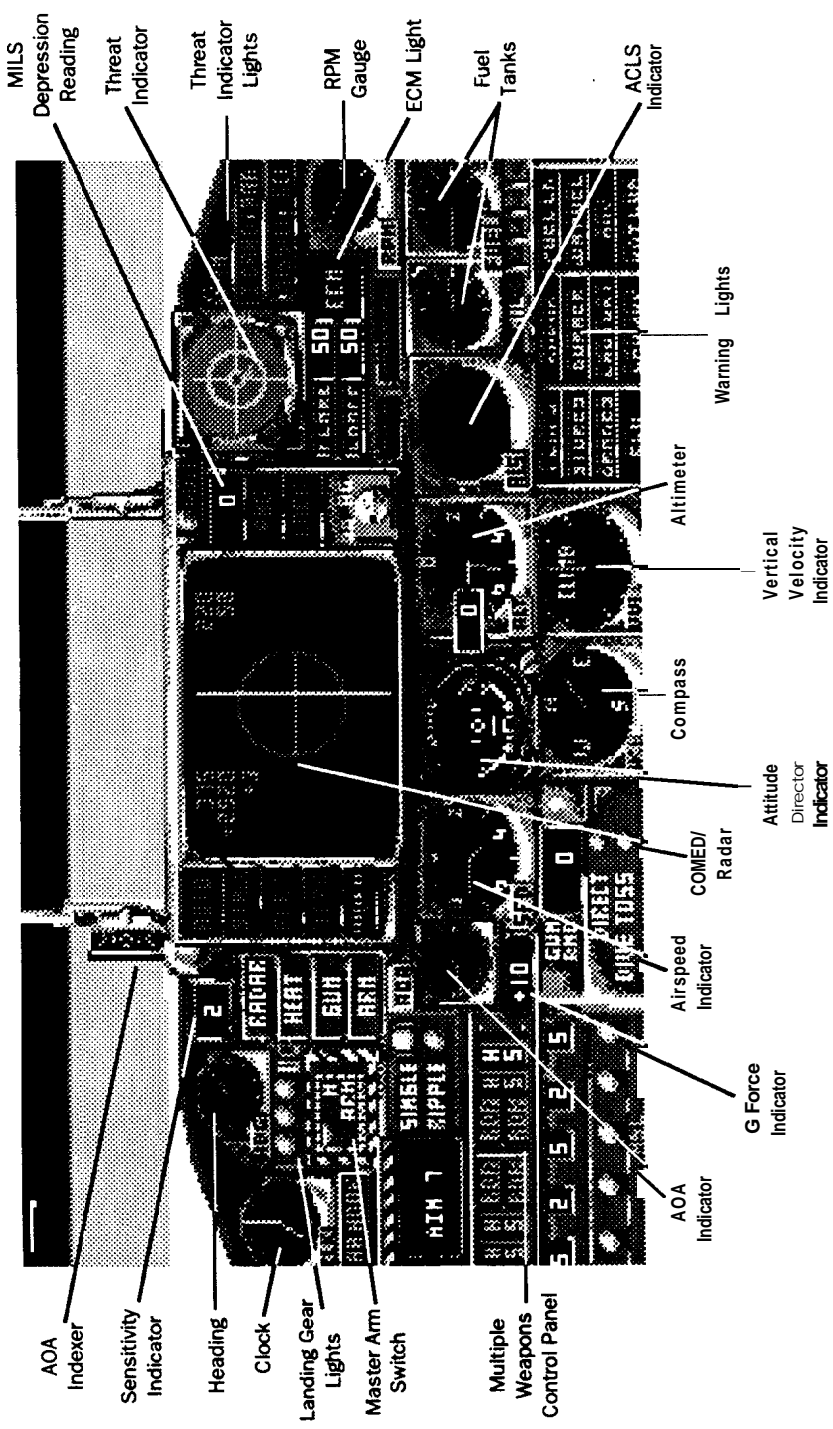

A-6 Intruder Cockpit (Front Panel')

